

# Mod. FEX

Low-pressure gas regulator

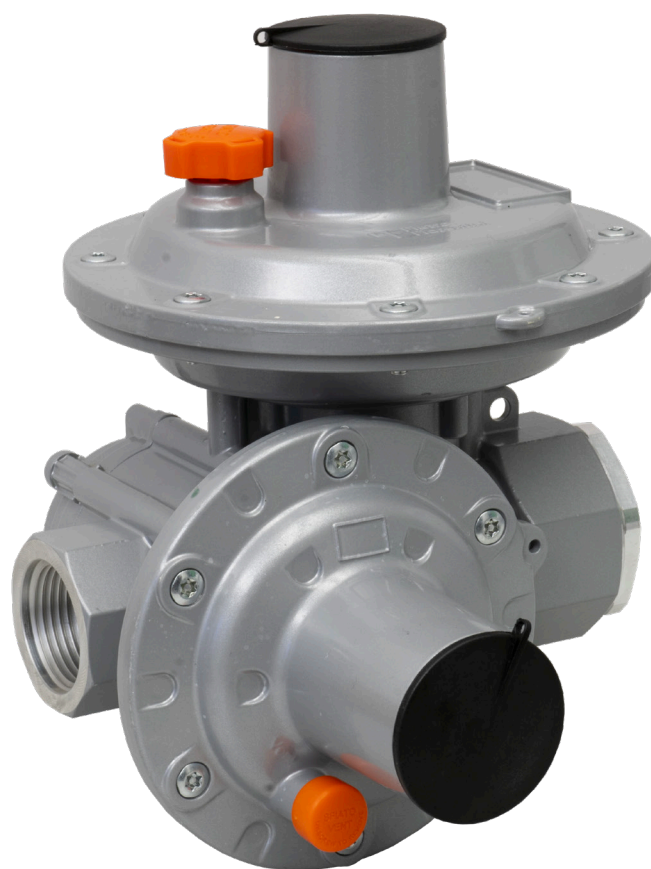

**TECHNICAL BROCHURE**

**Pietro Fiorentini S.p.A.**

Via E.Fermi, 8/10 | 36057 Arcugnano, Italy | +39 0444 968 511  
sales@fiorentini.com

The data contained in this document are not binding.  
Pietro Fiorentini reserves the right to make changes without prior notice.

modfex\_technicalbrochure\_ENG\_revA

**[www.fiorentini.com](http://www.fiorentini.com)**

# Who we are

We are an international company specialising in the design and manufacture of cutting-edge devices and solutions for natural gas processing, transport and distribution systems. We are the ideal partner for operators in the Oil & Gas sector, with a business offer that goes across the whole natural gas chain.

We are in constant evolution to meet our customers' highest expectations in terms of quality and reliability.

Our aim is to be a step ahead of the competition, with customized technologies and an after-sale service program undertaken with the highest grade of professionalism.



## Pietro Fiorentini advantages



Localised technical support



Experience since 1940



We operate in over 100 countries

# Application area

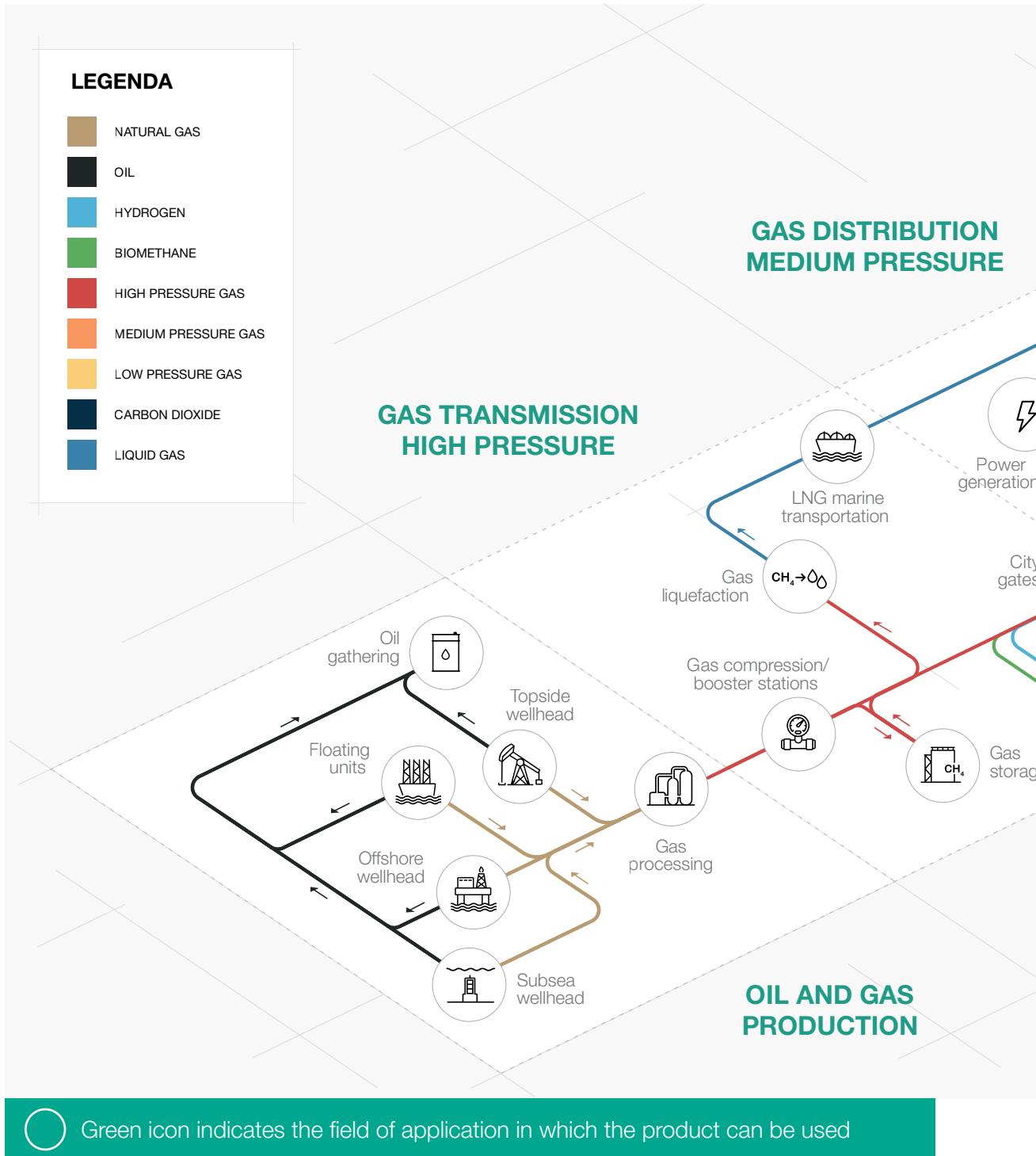

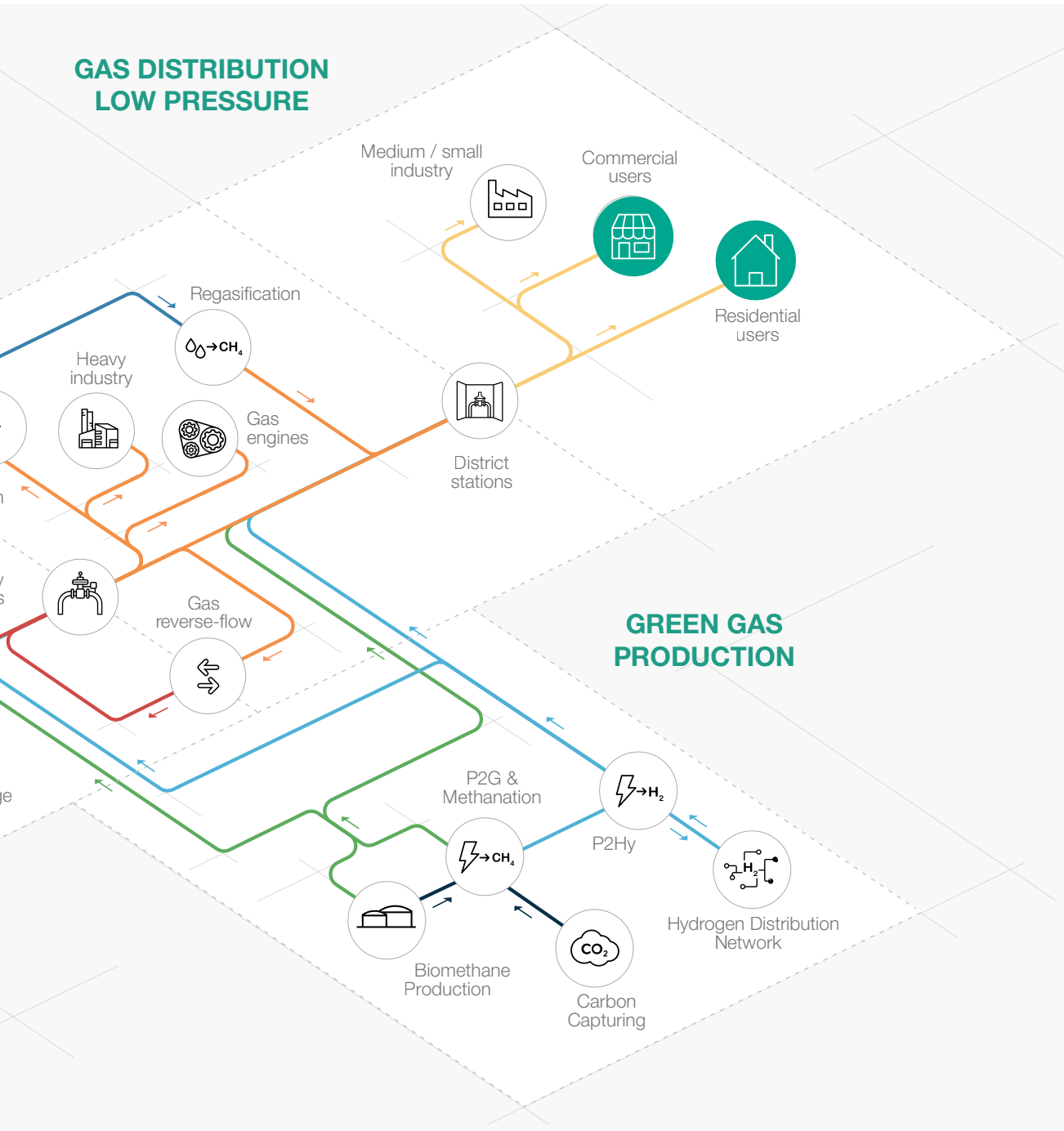

**Figure 1** Map of application areas



# Introduction

**FEX** is one of the **direct-operated gas pressure regulators** designed and manufactured by Pietro Fiorentini.

This device is suitable for use with previously filtered, non-corrosive gases and is particularly indicated for low-pressure natural gas distribution networks for commercial fixtures.

The **FEX** regulator is classified as **Fail Close** (only the version with slam-shut device for downstream overpressure).

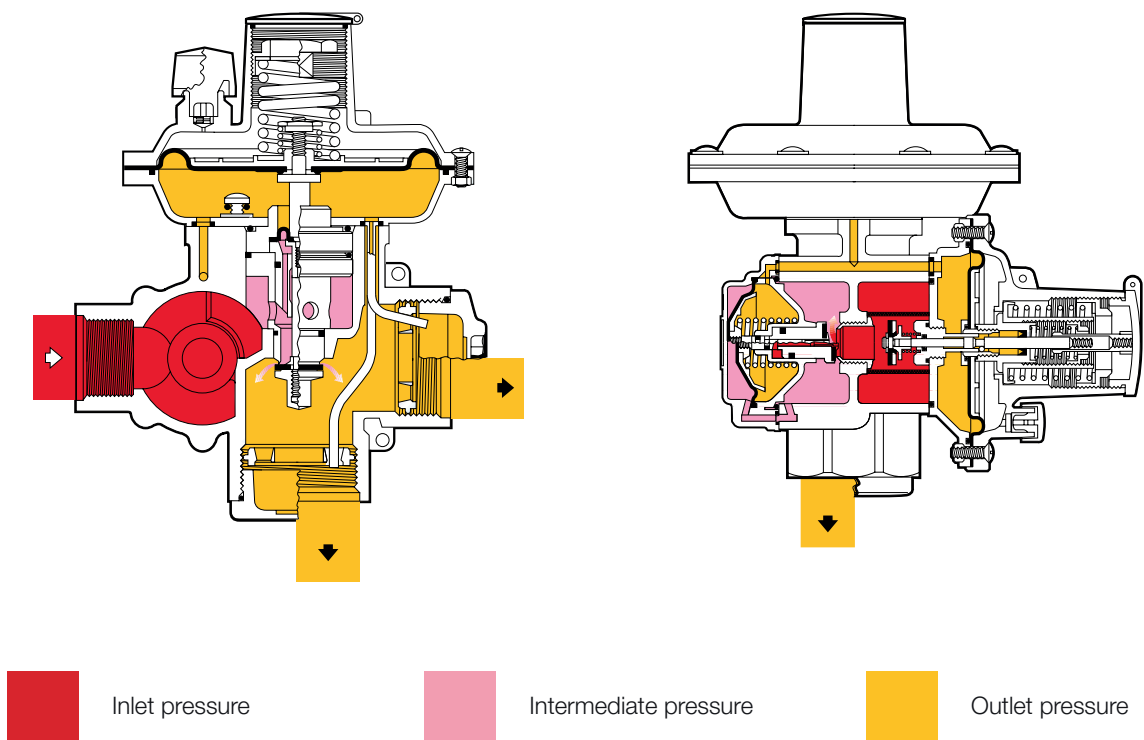

**Figure 2** FEX

# Description and Calibration interval

**FEX** is a **direct-operated pressure regulator** that provides extremely accurate control of the outlet pressure.

The two-stage regulation system with a balanced first stage, combined with a balanced second stage, ensures a constant downstream pressure value as a function of the inlet pressure and the required flow rate.

This regulator is suitable for use with previously filtered, non-corrosive gases, in natural gas transmission and distribution networks as well as low load residential application.

The design of the **FEX** regulator allows for easy installation in all the inlet and outlet pipe positions that the field conditions may have.

The FEX regulator is also set up for customisation in terms of calibration, compression fittings, safety devices, etc.

## FEX competitive advantages



Operates with low differential pressure



Slam-shut valve for overpressure  
Slam-shut valve for underpressure



Two-stage regulation with balanced first and second stage plug



High customisation



Built-in filter



Integrated thermal valve option



Suitable for outdoor installations



Compatible with biomethane and blended hydrogen up to 20%.  
Higher mixtures available on request

## Features

Features	Values	
Design pressure (DP)	0.86 MPa 8.6 bar	
Inlet pressure range	0.01 - 0.86 MPa 0.1 - 8.6 bar	
Regulator capacity	1765 - 3530 ft <sup>3</sup> /h 50 - 100 m <sup>3</sup> /h	
Adjustment range of downstream pressure	<b>BP Version</b>	1.3 - 9.9 kPa 13 - 99 mbar
	<b>MP version</b>	10 - 35 kPa 100 - 350 mbar
Accuracy class (AC)	10	
Lock-up over pressure (SG)	20	
Operating ambient temperature*	<b>Standard version</b>	from -20 °C to +60 °C from -4 °F to +140 °F
	<b>Low temperature version (Subzero)</b>	from -40°C to + 60°C from -40 °F to +140 °F
Permissible gas temperature	<b>Standard version</b>	from -10°C to + 60°C from +14 °F to +140 °F
	<b>Low temperature version (Subzero)</b>	from -20 °C to +60 °C from -4 °F to +140 °F
Inlet connection	G 1" EN ISO 228/1 (modular connections on request)	
Outlet connection	<ul style="list-style-type: none"> <li>In-line outlet: G 1" 1/2 EN ISO 228/1</li> <li>Outlet in a square pattern: G 1" 1/2" EN ISO 228/1</li> </ul> (modular connections on request)	
Modular connections	<ul style="list-style-type: none"> <li>Gas (as per UNI EN ISO 228-1:2003);</li> <li>Flat swivel joint (as per NF E29-533: 2014 and NF E29-536: 2017);</li> <li>NPT (according to ASME B1.20.1, excluding connections with metal/metal sealing);</li> <li>Special accessories (on request).</li> </ul>	

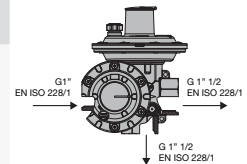

**(\*) REMARK: Different functional features and/or extended temperature ranges available on request. Stated temperature ranges are the maximum for which the equipment's full performance, including accuracy, are fulfilled. Standard product may have a narrower range.**

**Table 1** Features



# Materials and Approvals

Part	Material
<ul style="list-style-type: none"> <li>• Diaphragm</li> <li>• O-rings</li> </ul>	Nitrile rubber (MP rubberised canvas)
<ul style="list-style-type: none"> <li>• Caps</li> <li>• Discs</li> </ul>	Plastic
<ul style="list-style-type: none"> <li>• Springs</li> </ul>	Steel
<ul style="list-style-type: none"> <li>• Equipment body</li> <li>• Lids</li> </ul>	Aluminium alloy

**Table 2** Materials

## Construction Standards and Approvals

The **FEX** regulator is designed in compliance with European standard EN 13611.

Based on the version/configuration, the fe regulator complies with:



EN 13611



UNI 8827



EN 16129



EN 88-2



UNI 11655



CSA 6.18



ANSI  
B109.4



NF  
E29-190-2



# Spring ranges

## FEX STD / FEX NO SLAM-SHUT DEVICE

BP FEX 50-75-100 VERSION							
Pos.	Spring item code	Spring colour	d	Lo	De	Spring range (mbar)	
						Min.	Max.
1	64470171BI	White	1.8	57	34	13	19
	64470027VER	Green	1.2	30	15.4		
2	64470130AR	Orange	1.8	78	34	20	26
	64470030NER	Black	1.2	35	15		
3	64470131VE	Green	2.2	70	34	27	39
	64470030NER	Black	1.2	35	15		
4	64470132RO	Red	2.4	67	34	40	59
	64470030NER	Black	1.2	35	15		
5	64470133BL	Blue	2.4	84	34	60	79
	64470030NER	Black	1.2	35	15		
6	64470134AZ	Sky blue	3	65	34	80	99
	64470030NER	Black	1.2	35	15		

**d** = Wire Diameter (mm)   **Lo** = Spring Length (mm)   **De** = External Diameter (mm)

**Table 3** BP FEX 50-75-100 version calibration

BP FEX 50-75-100 SLAM-SHUT VALVE FOR OVERPRESSURE							
Pos.	Spring item code	Spring colour	d	Lo	De	Spring range (mbar)	
						Min.	Max.
1	64470111VE	Green	2	45	34	32	54
2	64470113AZ	Sky blue	2.3	44	34	55	99
3	64470114MA	Brown	2.4	51	34	100	160

**d** = Wire Diameter (mm)   **Lo** = Spring Length (mm)   **De** = External Diameter (mm)

**Table 4** Calibration of BP FEX 50-75-100 slam-shut valve for overpressure

BP FEX 50-75-100 SLAM-SHUT VALVE FOR UNDERPRESSURE							
Pos.	Spring item code	Spring colour	d	Lo	De	Spring range (mbar)	
						Min.	Max.
1	64470308NE	Black	1.1	29.5	15.2	6	14
2	64470128VE	Green	1.3	35	15	15	39
3	64470024BI	White	1.3	45	15	40	79
4	64470031RO	Red	1.7	40	15	80	139
5	64470038GI	Yellow	2	40	15	140	250

**d** = Wire Diameter (mm)   **Lo** = Spring Length (mm)   **De** = External Diameter (mm)

**Table 5** Calibration of BP FEX 50-75-100 slam-shut valve for underpressure

RELIEF VALVE BP FEX 50-75-100		
Spring item code	Spring range (mbar)	
	Min.	Max.
64470027VER	10	15
64470030NER	16	34

**Table 6** Relief valve calibration BP FEX 50-75-100;

\*the spring ranges refer to the differential between the regulator calibration and relief activation.

MP FEX 50-75-100 VERSION							
Pos.	Spring item code	Spring colour	d	Lo	De	Spring range (mbar)	
						Min.	Max.
1	64470134AZ	Sky blue	3	65	34	100	119
	64470024BI	White	1.3	45	15		
2	64470135GI	Yellow	3.2	63	34	120	209
	64470024BI	White	1.3	45	15		
3	64470136GR	Grey	3.5	69	34	210	350
	64470040GR	Grey	1.5	44	15		

**d** = Wire Diameter (mm)   **Lo** = Spring Length (mm)   **De** = External Diameter (mm)

**Table 7** MP FEX 50-75-100 version calibration

MP FEX 50-75-100 SLAM-SHUT VALVE FOR OVERPRESSURE							
Pos.	Spring item code	Spring colour	d	Lo	De	Spring range (mbar)	
						Min.	Max.
1	64470115GR	Grey	2.8	42	34	115	209
2	64470116GI	Yellow	3.2	40	34	210	329
3	64470416BI	White	3.1	48	34	330	500

**d** = Wire Diameter (mm)   **Lo** = Spring Length (mm)   **De** = External Diameter (mm)

**Table 9** Calibration of MP FEX 50-75-100 slam-shut valve for overpressure

MP FEX 50-75-100 SLAM-SHUT VALVE FOR UNDERPRESSURE							
Pos.	Spring item code	Spring colour	d	Lo	De	Spring range (mbar)	
						Min.	Max.
3	64470024BI	White	1.3	45	15	40	79
4	64470031RO	Red	1.7	40	15	80	139
5	64470038GI	Yellow	2	40	15	140	250

**d** = Wire Diameter (mm)   **Lo** = Spring Length (mm)   **De** = External Diameter (mm)

**Table 8** Calibration of MP FEX 50-75-100 slam-shut valve for underpressure



RELIEF VALVE MP FEX 50-75-100		
Spring item code	Spring range (mbar)	
	Min.	Max.
64470024BI	35	70
64470040GR	71	110

**Table 10** Relief valve calibration MP FEX 50-75-100;  
\*the spring ranges refer to the differential between the regulator calibration and relief activation.

## FEX CSA

BP FEX CSA 50-75-100 VERSION							
Pos.	Spring item code	Spring colour	d	Lo	De	Spring range (mbar)	
						Min.	Max.
1	64470171BI	White	1.8	57	34	13	19
	64470027VER	Green	1.2	30	15.4		
2	64470130AR	Orange	1.8	78	34	20	26
	64470027VER	Green	1.2	30	15.4		
3	64470131VE	Green	2.2	70	34	27	39
	64470030NER	Black	1.2	35	15		
4	64470132RO	Red	2.4	67	34	40	59
	64470030NER	Black	1.2	35	15		
5	64470133BL	Blue	2.4	84	34	60	79
	64470030NER	Black	1.2	35	15		
6	64470134AZ	Sky blue	3	65	34	80	99
	64470024BI	White	1.3	45	15		
7	64470135GI	Yellow	3.2	63	34	100	160
	64470024BI	White	1.3	45	15		

**d** = Wire Diameter (mm)    **Lo** = Spring Length (mm)    **De** = External Diameter (mm)

**Table 11** BP FEX CSA 50-75-100 version calibration

BP FEX CSA 50-75-100 SLAM-SHUT VALVE FOR OVERPRESSURE							
Pos.	Spring item code	Spring colour	d	Lo	De	Spring range (mbar)	
						Min.	Max.
1	64470111VE	Green	2	45	34	31.5	54.25
2	64470113AZ	Sky blue	2.3	44	34	54.5	99.5
3	64470114MA	Brown	2.4	51	34	100	160
4	64470115GR	Grey	2.8	42	34	160.5	210
5	64470116GI	Yellow	3.2	40	34	210.5	231

**d** = Wire Diameter (mm)    **Lo** = Spring Length (mm)    **De** = External Diameter (mm)

**Table 12** Calibration of BP FEX CSA 50-75-100 slam-shut valve for overpressure

BP FEX CSA 50-75-100 SLAM-SHUT VALVE FOR UNDERPRESSURE							
Pos.	Spring item code	Spring colour	d	Lo	De	Spring range (mbar)	
						Min.	Max.
1	64470308NE	Black	1.1	29.5	15.2	6	14.75
2	64470128VE	Green	1.3	35	15	15	39.5
3	64470024BI	White	1.3	45	15	40	79.5
4	64470031RO	Red	1.7	40	15	80	139.5
5	64470038GI	Yellow	2	40	15	140	250

**d** = Wire Diameter (mm)   **Lo** = Spring Length (mm)   **De** = External Diameter (mm)

**Table 13** Calibration of BP FEX CSA 50-75-100 slam-shut valve for underpressure

RELIEF VALVE BP FEX CSA 50-75-100		
Spring item code	Spring range (mbar)	
	Min.	Max.
64470027VER	10	15
64470030NER	16	34

**Table 14** Relief valve calibration BP FEX CSA 50-75-100;  
\*the spring ranges refer to the differential between the regulator calibration and relief activation.

MP FEX CSA 50-75-100 VERSION							
Pos.	Spring item code	Spring colour	d	Lo	De	Spring range (mbar)	
						Min.	Max.
1	64470135GI	Yellow	3.2	63	34	140	210
	64470024BI	White	1.3	45	15		
2	64470136GR	Grey	3.5	69	34	210.5	350
	64470040GR	Grey	1.5	44	15		

**d** = Wire Diameter (mm)   **Lo** = Spring Length (mm)   **De** = External Diameter (mm)

**Table 15** MP FEX CSA 50-75-100 version calibration

MP FEX CSA 50-75-100 SLAM-SHUT VALVE FOR OVERPRESSURE							
Pos.	Spring item code	Spring colour	d	Lo	De	Spring range (mbar)	
						Min.	Max.
1	64470116GI	Yellow	3.2	40	34	210.5	329.5
2	64470416BI	White	3.1	48	34	330	552

**d** = Wire Diameter (mm)   **Lo** = Spring Length (mm)   **De** = External Diameter (mm)

**Table 16** Calibration of MP FEX CSA 50-75-100 slam-shut valve for overpressure



























RELIEF VALVE MP FEX CSA 50-75-100		
Spring item code	Spring range (mbar)	
	Min.	Max.
64470024BI	35	70
64470040GR	71	110

**Table 17** Relief valve calibration MP FEX CSA 50-75-100;  
\*the spring ranges refer to the differential between the regulator calibration and relief activation.

General link to the calibration tables: [CLICK HERE](#) or use the QR code:



# Versions

	models		
	FEX STD	FEX NO SLAM-SHUT DEVICE	FEX CSA
Image			
Description	Standard version	Version without overpressure slam-shut device	Specific version for the North American market
<b>Al</b> Aluminium version			
<b>UPSO</b> Downstream underpressure slam-shut device			
<b>OPSO</b> Downstream overpressure slam-shut device			
 Relief valve			
 Output configuration in line and in a square pattern			
 Outdoor installation not protected			
 Univent version			

**Table 18** Available versions of the FEX regulator



# Weights and dimensions

## FEX STD

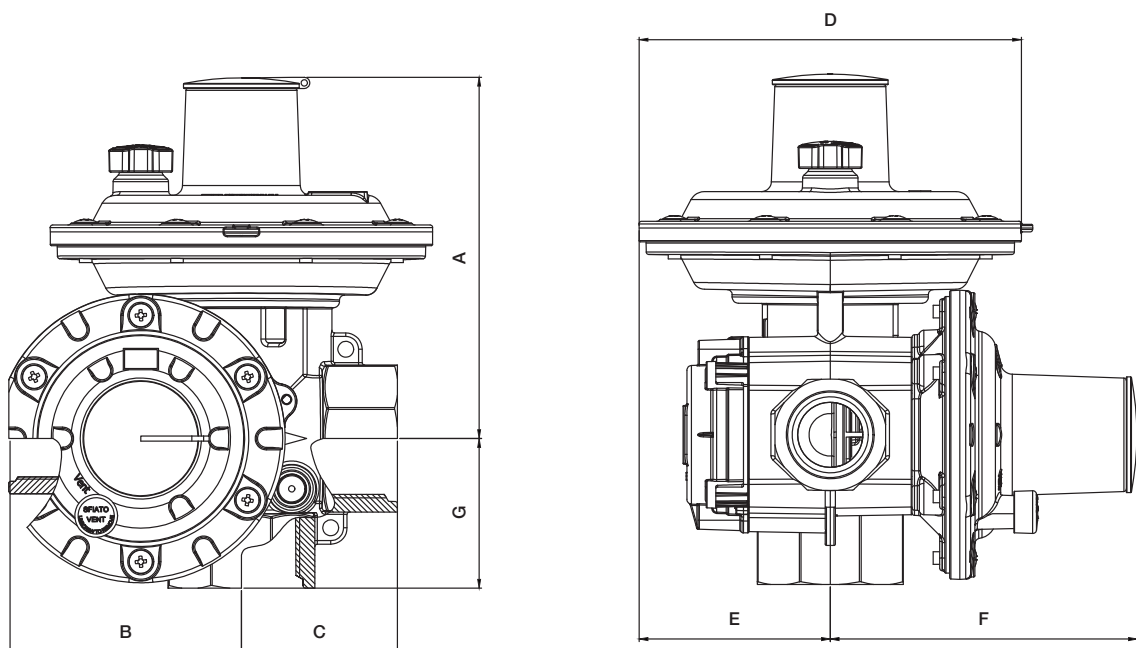

**Figure 3** FEX STD dimensions

Weights and Dimensions (for other connections, please contact your closest Pietro Fiorentini representative)		
	[mm]	inches
A	144	5.7"
B	92	3.6"
C	62	2.4"
D	Ø152	Ø6.0"
E	76	3.0"
F	122	4.8"
G	60	2.4"
<b>Weight</b>	<b>Kg</b>	<b>pounds</b>
	2.1	4.6

**Table 19** Weights and dimensions



## FEX NO SLAM-SHUT DEVICE

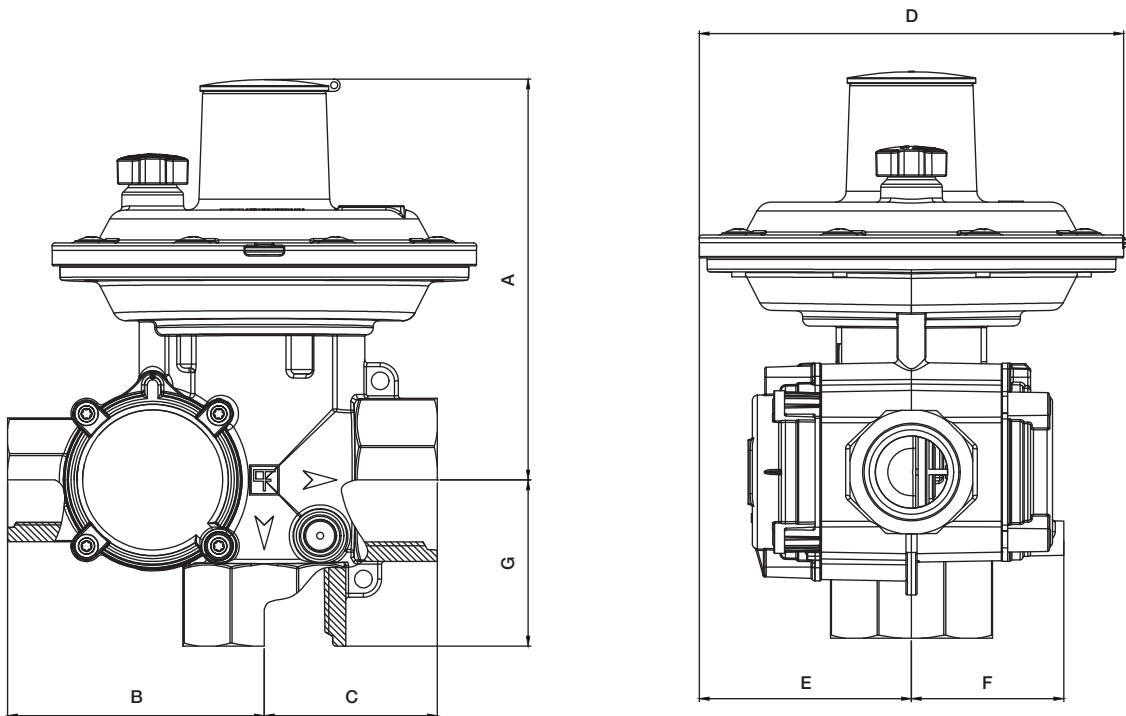

**Figure 4** FEX NO SLAM-SHUT DEVICE Dimensions

Weights and Dimensions (for other connections, please contact your closest Pietro Fiorentini representative)		
	[mm]	inches
A	144	5.7"
B	92	3.6"
C	62	2.4"
D	Ø152	Ø6.0"
E	76	3.0"
F	55	2.2"
G	60	2.4"
Weight	Kg	pounds
	1.6	3.5

**Table 20** Weights and dimensions



## FEX CSA

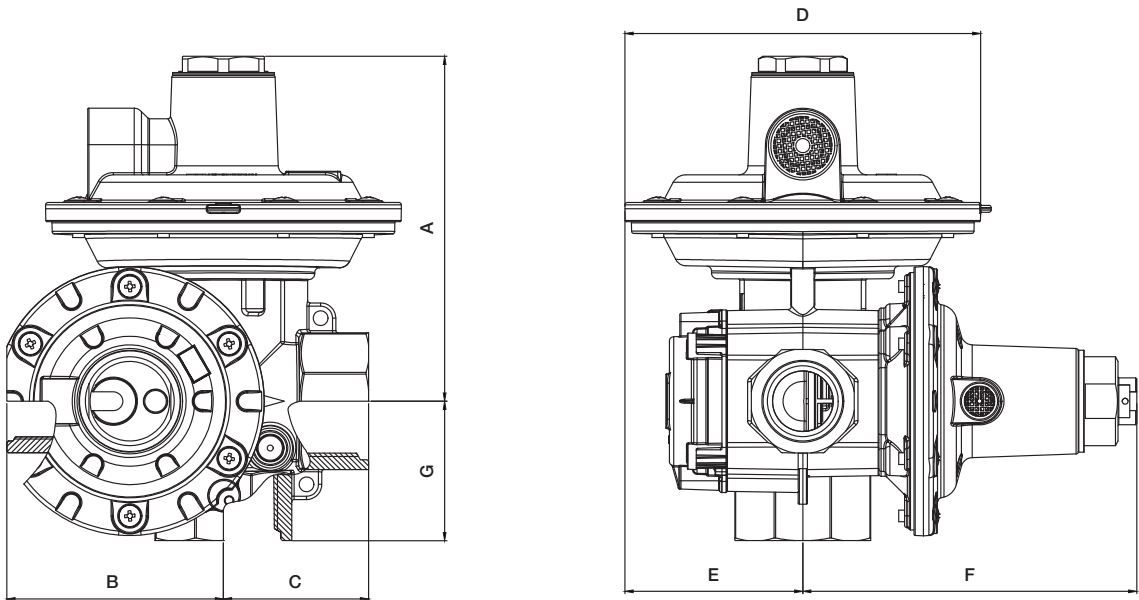

**Figure 5** FEX CSA dimensions

Weights and Dimensions (for other connections, please contact your closest Pietro Fiorentini representative)		
	[mm]	inches
A	147	5.8"
B	92	3.6"
C	62	2.4"
D	Ø152	Ø6.0"
E	76	3.0"
F	143	5.6"
G	60	2.4"
Weight	Kg	pounds
	2.2	4.9

**Table 21** Weights and dimensions



**Pietro  
Fiorentini**



# Pietro Fiorentini

**TB0080ENG**



The data are not binding. We reserve the right  
to make changes without prior notice.

modfex\_technicalbrochure\_ENG\_revA

[www.fiorentini.com](http://www.fiorentini.com)