

# VS/AM 58

Relief valve



Revision A - Edition 06/2023

**USE, MAINTENANCE  
AND WARNING  
MANUAL**



# 1 - INTRODUCTION

## FOREWORD

All rights reserved. No part of this publication may be reproduced, distributed, translated into other languages or transmitted by any electronic or mechanical media, including photocopies, recording or any other storage and retrieval system, for any other purposes that are not exclusively the personal use of the buyer, without the express written permission of the Manufacturer.

The manufacturer is in no way responsible for the consequences of operations carried out in a manner not in accordance with the manual.

## GENERAL REMARKS

All operating, maintenance instructions and recommendations described in this manual must be followed to in order to:

- get the best possible performance from the device;
- maintain the device in an efficient condition;
- carry out maintenance work regularly.

Training the personnel in charge is essential in order to:

- the use and maintenance of the device in the correct manner;
- correctly apply the safety alerts and recommended procedures.

Revision: A



## 1.1 - REVISION HISTORY

Revision index	Date	Revision contents
<b>A</b>	06/2023	First issue

Tab. 1.1.

# INDICE

<b>1 - INTRODUCTION .....</b>	<b>3</b>
1.1 - REVISION HISTORY.....	5
<b>2 - GENERAL INFORMATION .....</b>	<b>9</b>
2.1 - MANUFACTURER IDENTIFICATION .....	9
2.2 - IDENTIFICATION OF THE PRODUCT .....	9
2.3 - REGULATORY FRAMEWORK.....	9
2.4 - WARRANTY .....	10
2.5 - SYMBOLS USED IN THE MANUAL.....	10
2.6 - ADDRESSEES, SUPPLY AND STORAGE OF THE MANUAL .....	11
2.7 - LANGUAGE .....	11
2.8 - APPLIED RATING PLATES .....	12
2.8.1 - GLOSSARY FOR RATING PLATES.....	13
2.9 - GLOSSARY OF MEASUREMENT UNITS.....	13
2.10 -QUALIFIED PROFESSIONAL FIGURES.....	14
<b>3 - SAFETY .....</b>	<b>15</b>
3.1 - GENERAL SAFETY WARNINGS.....	15
3.2 - PERSONAL PROTECTIVE EQUIPMENT.....	16
3.3 - RESIDUAL RISKS .....	17
3.3.1 - TABLE SHOWING RESIDUAL RISKS DUE TO PRESSURE .....	18
3.3.2 - TABLE OF RESIDUAL RISKS FOR POTENTIALLY EXPLOSIVE ATMOSPHERES .....	20
3.4 - OBLIGATIONS AND PROHIBITIONS .....	22
3.5 - SAFETY PICTOGRAMS .....	22
3.6 - NOISE LEVEL .....	22
<b>4 - DESCRIPTION AND OPERATION .....</b>	<b>23</b>
4.1 - GENERAL DESCRIPTION .....	23
4.2 - OPERATION.....	24
4.3 - INTENDED USE .....	25
4.3.1 - ENVISAGED USE .....	25
4.3.2 - REASONABLY FORESEEABLE MISUSE .....	25
4.3.3 - TYPES OF FLUIDS .....	25
4.4 - TECHNICAL FEATURES/PERFORMANCE .....	26

## **5 - TRANSPORT AND HANDLING ..... 27**

5.1 - SPECIFIC WARNINGS FOR TRANSPORT AND HANDLING .....	27
5.1.1 - PACKAGING AND FASTENERS USED FOR TRANSPORT .....	28
5.2 - PACKAGING CONTENT.....	28
5.3 - PHYSICAL CHARACTERISTICS OF THE DEVICE .....	29
5.3.1 - STANDARD VERSION .....	29
5.3.2 - FLANGED VERSION .....	30
5.4 - DEVICE ANCHORING AND LIFTING METHOD .....	31
5.4.1 - FORKLIFT HANDLING METHOD.....	32
5.5 - PACKAGING REMOVAL.....	34
5.5.1 - PACKAGING DISPOSAL .....	34
5.6 - STORAGE AND ENVIRONMENTAL CONDITIONS .....	35
5.6.1 - STORAGE LASTING LONGER THAN THE MAXIMUM TIME ALLOWED.....	35

## **6 - INSTALLATION ..... 36**

6.1 - INSTALLATION PRE-REQUISITES.....	36
6.1.1 - ALLOWED ENVIRONMENTAL CONDITIONS.....	36
6.1.2 - STORAGE LASTING LONGER THAN THE MAXIMUM TIME ALLOWED .....	36
6.1.3 - CHECKS BEFORE INSTALLATION.....	37
6.2 - SPECIFIC SAFETY INSTRUCTIONS FOR THE INSTALLATION STEP .....	38
6.3 - POSSIBLE INSTALLATIONS OF THE DEVICE .....	39
6.4 - INSTALLATION PROCEDURE .....	40
6.4.1 - DEVICE INSTALLATION PROCEDURE .....	41
6.5 - POST-INSTALLATION CHECKS .....	41

## **7 - COMMISSIONING/MAINTENANCE EQUIPMENT..... 42**

7.1 - LIST OF EQUIPMENT.....	42
------------------------------	----

## **8 - COMMISSIONING ..... 43**

8.1 - GENERAL WARNINGS .....	43
8.1.1 - SAFETY REQUIREMENTS FOR COMMISSIONING .....	43
8.2 - PRELIMINARY PROCEDURES FOR COMMISSIONING .....	44
8.3 - PROPER COMMISSIONING CHECK .....	45
8.4 - CALIBRATION OF EQUIPMENT AND ACCESSORIES INSTALLED.....	45
8.5 - RELIEF VALVE COMMISSIONING PROCEDURE VS/AM 58.....	46
8.5.1 - WITH EXTERNAL PRESSURE SOURCE .....	46
8.5.2 - WITHOUT EXTERNAL PRESSURE SOURCE .....	48

## **9 - MAINTENANCE AND FUNCTIONAL CHECKS..... 49**

9.1 - GENERAL WARNINGS .....	49
9.2 - PERIODICALLY CHECKING AND INSPECTING THE EQUIPMENT FOR PROPER OPERATION.....	51
9.3 - ROUTINE MAINTENANCE .....	52
9.3.1 - GENERAL SAFETY WARNINGS.....	52
9.3.2 - REPLACEMENT FREQUENCY FOR COMPONENTS SUBJECT TO WEAR .....	52
9.4 - ROUTINE MAINTENANCE PROCEDURES.....	54
9.4.1 - PRELIMINARY OPERATIONS.....	54
9.4.2 - DISASSEMBLY/REASSEMBLY.....	54
9.4.3 - REPLACING ELEMENTS SUBJECT TO WEAR AND ABRASION.....	55
9.4.4 - RELIEF VALVE MAINTENANCE PROCEDURE VS/AM 58.....	58
9.4.5 - PROCEDURE FOR RECOMMISSIONING AFTER MAINTENANCE .....	64

## **10 - TROUBLESHOOTING..... 65**

10.1 -GENERAL WARNINGS .....	65
10.2 -OPERATOR QUALIFICATION SPECIFICATION.....	66
10.3 -TROUBLESHOOTING PROCEDURES .....	66
10.4 -TROUBLESHOOTING TABLE.....	66

## **11 - UNINSTALLATION AND DISPOSAL ..... 67**

11.1 -GENERAL SAFETY WARNINGS.....	67
11.2 -QUALIFICATION OF THE OPERATORS IN CHARGE.....	67
11.3 -UNINSTALLATION.....	67
11.4 -INFORMATION REQUIRED IN CASE OF RE-INSTALLATION.....	68
11.5 -DISPOSAL INFORMATION.....	68

## **12 - RECOMMENDED SPARE PARTS ..... 69**

12.1 -GENERAL WARNINGS .....	69
12.2 -HOW TO REQUEST SPARE PARTS.....	69

## **13 - CALIBRATION TABLES ..... 71**

13.1 -CALIBRATION TABLES.....	71
13.1.1 - SAFETY VALVE VERSION.....	71
13.1.2 - RELIEF VALVE VERSION .....	71



## 2 - GENERAL INFORMATION

### 2.1 - MANUFACTURER IDENTIFICATION

<b>Manufacturer</b>	PIETRO FIORENTINI S.P.A.
<b>Address</b>	Via Enrico Fermi, 8/10 36057 Arcugnano (VI) - ITALY <b>Tel. +39 0444 968511 Fax +39 0444 960468</b> <b>www.fiorentini.com sales@fiorentini.com</b>

Tab. 2.2.

#### **NOTICE!**

**For any problems with the device, please contact your gas network distributor.**

### 2.2 - IDENTIFICATION OF THE PRODUCT

<b>Device</b>	RELIEF VALVE
<b>Series</b>	VS/AM 58
<b>Available models</b>	<ul style="list-style-type: none"> <li>• VS/AM 58 BP</li> <li>• VS/AM 58 MP</li> <li>• VS/AM 58 TR</li> </ul>

Tab. 2.3.

### 2.3 - REGULATORY FRAMEWORK

PIETRO FIORENTINI S.P.A. with registered office in Arcugnano (Italy) - Via E. Fermi, 8/10, declares under its sole responsibility that the VS/AM 58 relief valve covered by this manual, is classified as a safety accessory and is:

- compliant with the Pressure Equipment Directive 2014/68/EU (PED);
- designed, manufactured, tested and controlled in accordance with the requirements of the standards: UNI 11655:2016, UNI EN 16129:2013, UNI EN 334:2019 where applicable.

#### **NOTICE!**

**For specific type approvals, see the appropriate section on the Manufacturer's website: <https://www.fiorentini.com>**

#### **NOTICE!**

**The declaration of conformity in its original version is delivered together with the device and this manual.**

## 2.4 - WARRANTY

PIETRO FIORENTINI S.P.A. guarantees that the device was manufactured using the best materials, with high quality workmanship, and complies with the quality requirements, specifications and performance set out in the order.



The warranty shall be considered null and void and PIETRO FIORENTINI S.P.A. shall not be liable for any damage and/or malfunctions:

- due to any acts or omissions of the purchaser or end-user, or any of their carriers, employees, agents, or any third party or entity;
- in the event that the purchaser, or a third party, makes changes to the device supplied by PIETRO FIORENTINI S.P.A. without the prior written approval of the latter;
- in the event of failure by the purchaser to comply with the instructions contained in this manual, as provided by PIETRO FIORENTINI S.P.A.

### NOTICE!

**The warranty conditions are specified in the commercial contract.**

## 2.5 - SYMBOLS USED IN THE MANUAL

Symbol	Definition
	Symbol used to identify important warnings for the safety of the operator and/or device.
	Symbol used to identify information of particular importance in the instruction manual. The information may also concern the safety of the personnel involved in using the device.
	Obligation to consult the instruction manual. Indicates a requirement for the personnel to refer to (and understand) the instruction manual before working with or on the device.

Tab. 2.4.

### HAZARD!

**Alerts to a hazard with a high level of risk, an imminent hazardous situation which, if not prevented, will result in death or severe damage.**

### WARNING!

**Alerts to a hazard with a medium level of risk, a potentially hazardous situation which, if not prevented, may result in death or severe damage.**

### ATTENTION!

**Alerts to a hazard with a low level of risk, a potentially hazardous situation which, if not prevented, could result in minor or moderate damage.**

### NOTICE!

**Alerts to specific warnings, directions or notes of particular concern, that are not related to physical injury, as well as practices for which physical injury is not likely to occur.**

## 2.6 - ADDRESSEES, SUPPLY AND STORAGE OF THE MANUAL

The instruction manual is intended for qualified technicians responsible for operating and managing the device throughout its service life.

It contains the necessary information to properly use the device and keep its functional and qualitative characteristics unchanged over time. All information and warnings for safe, correct use are also provided.

The manual, as well as the declaration of conformity and/or test certificate, is an integral part of the device and must always accompany it whenever it is moved or resold. It is the responsibility of the qualified professionals (see paragraph 2.10) to use and manage the device.

### **WARNING!**

**Removing, rewriting or editing the pages of the manual and their contents is not allowed.**

**PIETRO FIORENTINI S.p.A. shall not be held liable for any damage to people, animals and property caused by failure to adhere to the warnings and operating procedures described in this manual.**

## 2.7 - LANGUAGE

The original instruction manual was drawn up in Italian.

Any translations into additional languages are to be made from the original instruction manual.

### **HAZARD!**

**The Manufacturer is not responsible for any incomplete translations. If any inconsistency is found, please refer to the text of the original manual.**

**If inconsistencies are found or the text does not make sense:**

- **stop any actions;**
- **immediately contact PIETRO FIORENTINI S.p.A. at the addresses specified in paragraph 2.1 (“Identification of the manufacturer”).**

### **WARNING!**

**PIETRO FIORENTINI S.p.A. shall be held liable for the information provided in the original manual only.**

## 2.8 - APPLIED RATING PLATES

**⚠ WARNING!**

Removing nameplates and/or replacing them with other plates is strictly not allowed.  
Should the plates be unintentionally damaged or removed, the customer must notify  
**PIETRO FIORENTINI S.p.A.**

The device is equipped with rating plate (Fig. 2.1):

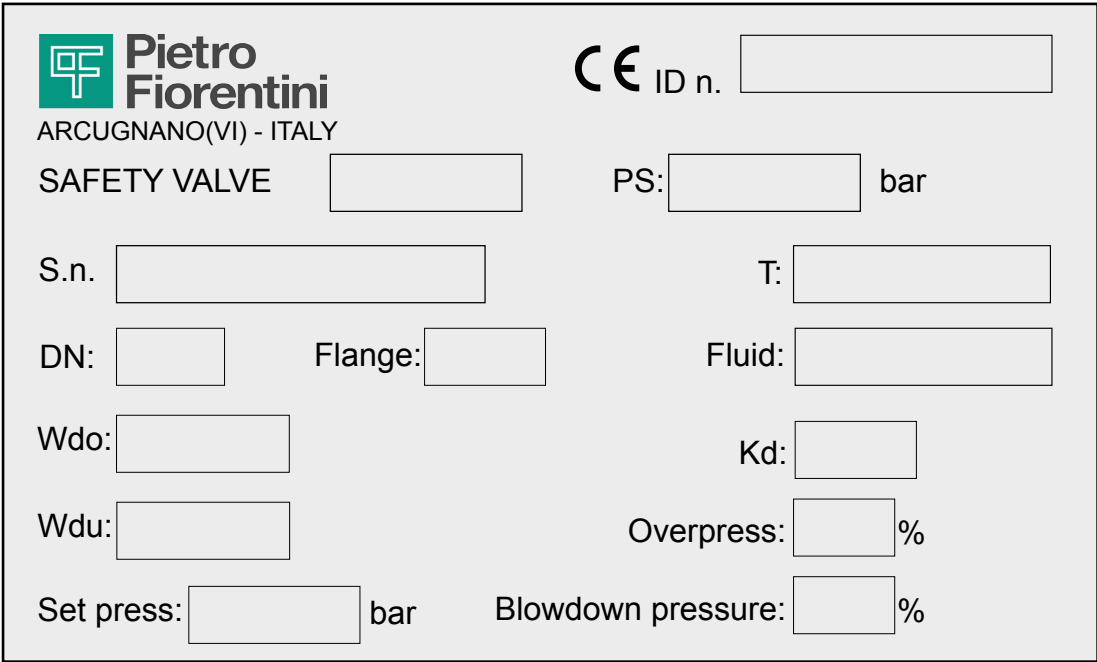

The diagram shows a rectangular rating plate with the following fields and labels:

- Pietro Fiorentini** logo and name, with **ARCUGNANO(VI) - ITALY** below it.
- SAFETY VALVE** label followed by a text input box.
- S.n.** (Serial number) label followed by a text input box.
- DN:** (Nominal diameter) label followed by a text input box.
- Wdo:** (Working diameter) label followed by a text input box.
- Wdu:** (Working diameter) label followed by a text input box.
- Set press:** (Set pressure) label followed by a text input box and the unit **bar**.
- CE** mark and **ID n.** (Identification number) label followed by a text input box.
- PS:** (Pressure setting) label followed by a text input box and the unit **bar**.
- T:** (Temperature) label followed by a text input box.
- Flange:** label followed by a text input box.
- Fluid:** label followed by a text input box.
- Kd:** (Coefficient) label followed by a text input box.
- Overpress:** (Overpressure) label followed by a text input box and the unit **%**.
- Blowdown pressure:** label followed by a text input box and the unit **%**.

Fig. 2.1. Positioning of rating plate

## 2.8.1 - GLOSSARY FOR RATING PLATES

The terms and abbreviations used on rating plates are described in Tab. 2.5:

Term	Description
<b>CE</b>	CE marking ensuring the conformity of the product with the requirements of the applicable EU directives or regulations.
<b>ID</b>	Identifier of the body that issued the CE marking.
<b>Model</b>	Device model.
<b>PS</b>	Maximum admissible pressure that can be supported in safe conditions by the structure of the body of the device (Bar).
<b>Wd</b>	Calibration range of the device that can be obtained by using the setting springs indicated in the appropriate tables.
<b>Relief</b>	Relief valve cut-in pressure (Bar).
<b>DN i/o</b>	Nominal diameter of device inlet/outlet connections.
<b>SN</b>	Serial number of the device.
<b>Fluid</b>	Type of gas that the device can be used with.
<b>TS</b>	Device design temperature range (°C).
<b>Wds</b>	Calibration range of the device that can be achieved using the parts and setting spring fitted at the time of testing (Bar).
<b>AG</b>	Accuracy of device intervention.
<b>Date</b>	Month and year of manufacture of the device.

Tab. 2.5.

## 2.9 - GLOSSARY OF MEASUREMENT UNITS

Type of measurement	Unit of measurement	Description
<b>Volumetric flow rate</b>	Sm <sup>3</sup> /h	Standard cubic metres per hour
	Sm <sup>3</sup>	Standard cubic metres
	m <sup>3</sup> /h	Cubic metres per hour
	m <sup>3</sup>	Cubic metres
<b>Pressure</b>	bar	Unit of measurement in the CGS system
	"wc	Water column inch
	Pa	Pascal
<b>Temperature</b>	°C	Degree centigrade
	°F	Fahrenheit degree
	K	Kelvin
<b>Tightening torque</b>	Nm	Newton metre
<b>Sound pressure</b>	dB	Decibel
<b>Other measures</b>	V	Volt
	W	Watt
	F	Farad
	H	Henry
	A	Ampere
	Ω	Ohm

Tab. 2.6.

## 2.10 - QUALIFIED PROFESSIONAL FIGURES

Qualified operators in charge of using and managing the device throughout its technical service life:

Professional figure	Definition
<b>Installer</b>	<p>Qualified operator able to:</p> <ul style="list-style-type: none"> <li>• handle materials and equipment;</li> <li>• carry out all the operations necessary to properly install the device;</li> <li>• perform all the operations necessary for the proper functioning of the device and the system in safety;</li> <li>• be able to perform all the operations necessary to uninstall and subsequently dispose of the device in compliance with the regulations in force in the country of installation.</li> </ul>
<b>User's technician / Specialised technician</b>	<p>Technician trained and authorised to use and manage the device for the activities it was supplied for. They must:</p> <ul style="list-style-type: none"> <li>• be able to perform all operations required for the proper functioning of the device and the system, and for their safety and that of any third parties present;</li> <li>• perform maintenance on all parts of the device subject to maintenance;</li> <li>• access all device parts for visual inspection, checking equipment status, making adjustments and calibrations;</li> <li>• have proven experience in properly using the equipment similar to that described in this manual, and be trained, informed and instructed in this regard.</li> </ul>

Tab. 2.7.

## 3 - SAFETY

### 3.1 - GENERAL SAFETY WARNINGS

#### WARNING!

The device described in this manual is:

- subject to pressure in pressurised systems;
- normally installed in systems carrying flammable gases (for example: natural gas).

#### WARNING!

If the gas used is a combustible gas, the installation area of the device is defined as a “danger zone” as there are residual risks that potentially explosive atmospheres may be generated.

In “danger zones” and in close proximity thereto:

- there must not be any effective sources of ignition;
- no smoking.

#### WARNING!

- It is strictly forbidden to repair or make any modifications to the device.
- For information and warnings concerning the maintenance of the device, please refer to Chapter 9 of this manual.

#### ATTENTION!

Authorised operators must not carry out operations or services on their own initiative that do not fall within their competence.

Never interfere with the device:

- while under the influence of intoxicating substances such as alcohol;
- if you are using drugs that may slow reaction times.

#### NOTICE!

The employer must train and inform operators:

- on how to behave during operations;
- on the equipment to be used.









Before installation, commissioning or maintenance, operators must:

- take note of the safety regulations applicable to the place of installation they are working in;
- obtain the necessary permits to operate when required;
- wear the personal protective equipment required by the procedures described in this instruction manual;
- ensure that the required collective protective equipment and safety information are available in the area they are operating in.

### 3.2 - PERSONAL PROTECTIVE EQUIPMENT

Tab. 3.8 shows the Personal Protective Equipment (PPE) and its description; an obligation is associated with each symbol. Personal protective equipment means any equipment intended to be worn by the worker in order to protect them against one or several risks that are likely to threaten their safety or health during work.

For the operators in charge, depending on the type of work requested, the most appropriate PPE of the following will be reported and must be used:

Symbol	Meaning
	<b>Obligation to use safety or insulated gloves.</b> Indicates a requirement for the personnel to use safety or insulated gloves.
	<b>Obligation to use safety goggles.</b> Indicates a requirement for personnel to use protective goggles for eye protection.
	<b>Obligation to use safety shoes.</b> Indicates a requirement for the personnel to use accident-prevention safety shoes.
	<b>Obligation to use noise protection equipment.</b> Indicates a requirement for the personnel to use ear muffs or ear plugs to protect their hearing.
	<b>Obligation to wear protective clothing.</b> Indicates a requirement for the personnel to wear specific protective clothing.
	<b>Obligation to use a protective mask.</b> Indicates a requirement for the personnel to use respiratory masks in the event of a chemical risk.
	<b>Obligation to use a protective helmet.</b> Indicates a requirement for the personnel to use protective helmets.
	<b>Obligation to wear high visibility vests.</b> Indicates a requirement for the personnel to use high visibility vests.

Tab. 3.8.

#### **WARNING!**

Each licensed operator is obliged to:

- **take care of his/her own health and safety and that of other people in the workplace who are affected by his/her actions or omissions, in accordance with the training, instructions and equipment provided by the employer;**
- **appropriately use the PPE made available;**
- **immediately report to the employer, the manager or the person in charge any deficiencies in the equipment and devices, as well as any dangerous conditions they may become aware of.**



### 3.3 - RESIDUAL RISKS

 **WARNING!**

**If there are any functional faults, do not operate.**

**Immediately contact PIETRO FIORENTINI S.p.A. for the necessary directions.**

In accordance with the requirements of PED Directive 2014/68/EU point 1.2 of Annex I, below is an assessment of the risks associated with the device and an indication of the principles adopted for their prevention, according to the following classification:

- a) Elimination and/or reduction of the risk.
- b) Application of appropriate protective measures.
- c) Information to users about residual risks.

### 3.3.1 - TABLE SHOWING RESIDUAL RISKS DUE TO PRESSURE

 **WARNING!**

If there are any functional faults, do not operate. Immediately contact **PIETRO FIORENTINI S.p.A.** for the necessary directions.

Risk and Hazard	Event and Cause	Effect and Consequence	Solution and Prevention
<b>Pressurised gas leak. Projection of metallic and non-pressurised parts.</b>	<ul style="list-style-type: none"> <li>Violent impact;</li> <li>Impact (also due to falling, improper handling, etc.).</li> </ul>	<ul style="list-style-type: none"> <li>Deformation;</li> <li>Broken connections and, if pressurised, even burst.</li> </ul>	<ol style="list-style-type: none"> <li>Handling and installation with appropriate devices to avoid localised stress.</li> <li>Installation in suitable places and spaces with appropriate guards and packaging.</li> <li>Information in the technical manual.</li> </ol>
<b>Pressurised gas leak. Projection of metallic and non-pressurised parts.</b>	<ul style="list-style-type: none"> <li>Use of inappropriate fluids.</li> </ul>	<ul style="list-style-type: none"> <li>Corrosion;</li> <li>Embrittlement;</li> <li>Explosion.</li> </ul>	<ol style="list-style-type: none"> <li>The user must check compliance of the used fluid with what is indicated on the installation sheet.</li> </ol>
<b>Pressurised gas leak. Projection of metallic and non-pressurised parts.</b>	<ul style="list-style-type: none"> <li>Operation at temperatures below the minimum permissible temperature.</li> </ul>	<ul style="list-style-type: none"> <li>Embrittlement;</li> <li>Breakage;</li> <li>Explosion.</li> </ul>	<ol style="list-style-type: none"> <li>Install in places where the temperature is not below the minimum permissible temperature and/or insulate the device adequately.</li> <li>The minimum temperature allowed is indicated on the data plate.</li> </ol>
<b>Pressurised gas leak. Projection of metallic and non-pressurised parts. Explosion.</b>	<ul style="list-style-type: none"> <li>Overpressure or exceedance of the rated limit values (maximum pressure allowed)</li> </ul>	<ul style="list-style-type: none"> <li>Explosion;</li> <li>Breaks;</li> <li>Cracks;</li> <li>Permanent deformations.</li> </ul>	<ol style="list-style-type: none"> <li>The device has appropriate design safety margins.</li> <li>The user must check the maximum pressure applicable to the equipment.</li> <li>The maximum allowable pressure is highlighted on the appropriate plate on the device.</li> </ol>
<b>Pressurised fluid leakage. Projection of metallic and non-pressurised parts.</b>	<ul style="list-style-type: none"> <li>Incorrect attachment of the device.</li> </ul>	<ul style="list-style-type: none"> <li>Deformation;</li> <li>Breakage.</li> </ul>	<ol style="list-style-type: none"> <li>The device is equipped with unified type process connections and compression fittings.</li> <li>The installer must ensure correct fixing to the line.</li> <li>Indications in the technical manual.</li> </ol>
<b>Explosion of the appliance pressurised fluid leakage. Projection of metallic parts.</b>	<ul style="list-style-type: none"> <li>Operation at temperatures above the maximum permissible temperature.</li> </ul>	<ul style="list-style-type: none"> <li>Reduction of mechanical resistance and breakage of the device;</li> <li>Explosion.</li> </ul>	<ol style="list-style-type: none"> <li>The commissioning technician must equip the system with suitable control and safety devices.</li> <li>The maximum permissible temperature is indicated on the installation sheet.</li> </ol>
<b>Pressurised gas leak. Projection of metallic and non-pressurised parts.</b>	<ul style="list-style-type: none"> <li>Electrostatic potential differential stray currents.</li> </ul>	<ul style="list-style-type: none"> <li>Corrosion localised in the device.</li> </ul>	<ol style="list-style-type: none"> <li>The commissioning technician must equip the device with the necessary means of protection and earthing if indicated on the installation sheet.</li> <li>The above requirements are indicated in the technical manual.</li> </ol>

Risk and Hazard	Event and Cause	Effect and Consequence	Solution and Prevention
<b>Pressurised gas leak.</b> <b>Projection of metallic and non-pressurised parts.</b>	<ul style="list-style-type: none"> <li>• Humidity;</li> <li>• Environments with aggressive atmosphere.</li> </ul>	<ul style="list-style-type: none"> <li>• Deterioration of external surfaces;</li> <li>• Corrosion.</li> </ul>	a. The user must shut off the line and contact PIETRO FIORENTINI S.p.A.

Tab. 3.9.

### 3.3.2 - TABLE OF RESIDUAL RISKS FOR POTENTIALLY EXPLOSIVE ATMOSPHERES

Tab. 3.10 shows the conditions that can lead to the generation of a potentially explosive atmosphere for the relief valve. The table is valid for use with natural gas with a density of no more than 0.8; for different densities, the installation and environmental conditions must also be evaluated.

#### **WARNING!**

**If the gas used is a combustible gas, the installation area of the device is defined as a “danger zone” as there are residual risks that potentially explosive atmospheres may be generated.**

**There must be no effective sources of ignition in “danger zones” and in close proximity thereto.**

Operating conditions	Potentially explosive atmosphere	Normative references	Management measures included in the instructions for use and warning
<b>First start-up</b>	No	<ul style="list-style-type: none"> <li>During the production cycle and before the CE marking according to Directive 2014/68/EC, the external tightness of the device is checked at a value of 1.1 PS, in accordance with Standard EN 334.</li> <li>Before commissioning, the external tightness of the portion of the system on which the device is installed is checked at a suitable pressure (according to Standards EN 12186 and EN 12279).</li> </ul>	The instructions for use indicate the need to meet the requirements in Standards EN 12186 and EN 12279.
<b>Operation in normal conditions</b>	No	<p>The indications in the previous point apply, in addition:</p> <ul style="list-style-type: none"> <li>the device is installed outdoors or in an environment with natural ventilation according to Standards EN 12186 and EN 12279;</li> <li>the installation is subject to surveillance according to current national rules/good practice/the device manufacturer's instructions (in accordance with the provisions of Standard EN 12186 and Standard EN 12279).</li> </ul>	<p>The instructions for use indicate that:</p> <ul style="list-style-type: none"> <li>any environment in which the device is installed must meet the requirement of Standards EN 12186 and EN 12279;</li> <li>periodic checks and maintenance must be carried out during surveillance in accordance with the national rules in force (if any), and with the specific manufacturer's recommendations.</li> </ul>
<b>Breakage of the control head diaphragm (malfunction)</b>	No	<p>This event must be considered a rare malfunction.</p> <p>All atmospheric pressure chambers delimited on at least one side by a diaphragm must be channelled to a safe area (in accordance with the provisions of Standard EN 12186 and Standard EN 12279).</p>	The instructions for use indicate the need to meet the requirements of Standards EN 12186 and EN 12279.
<b>Breakage of other non-metallic parts (malfunction)</b>	No	This type of malfunction is not reasonably expected as it involves static seals (to the outside) that cannot generate any external leakage.	-

Operating conditions	Potentially explosive atmosphere	Normative references	Management measures included in the instructions for use and warning
<b>Decommissioning</b>	No	<ul style="list-style-type: none"> <li>The pressure of the system section in which the device is installed must be reduced with appropriate vent lines channelled to a safe area (according to the provisions of Standard EN 12186 and Standard EN 12279).</li> <li>The residual gas must be discharged as indicated above.</li> </ul>	The instructions for use indicate the need to meet the requirements of Standards EN 12186 and EN 12279
<b>Reboot</b>	No	<ul style="list-style-type: none"> <li>After reassembling the regulator, carry out an external leakage test at a convenient pressure value as specified by the manufacturer.</li> <li>Before commissioning, the external tightness of the portion of the system on which the device is installed is checked at a suitable pressure (according to Standards EN 12186 and EN 12279).</li> </ul>	The instructions for use indicate: <ul style="list-style-type: none"> <li>the minimum conditions for testing internal leakage;</li> <li>the need to meet the requirements of Standards EN 12186 and EN 12279.</li> </ul>

Tab. 3.10.

### 3.4 - OBLIGATIONS AND PROHIBITIONS

The following is a list of obligations and prohibitions to be observed for the safety of the operator.

It is mandatory to:



- carefully read and understand the use, maintenance and warning manual;
- before installing the device, strictly refer to the details specified on the nameplates and in the manual;
- avoid knocks and violent impact that could damage the device.

It is forbidden to:

- operate in various capacities on the device without the PPE indicated in the work procedures described in this manual;
- operate in the presence of open flames or bring open flames close to the work area;
- smoking near the device or while working on it;
- use the device with parameters other than those indicated on the nameplate;
- use the device with gas units other than those indicated on the meter nameplate;
- use the device outside the operating temperature range declared on the identification plate and indicated in this manual;
- install or use the device in environments other than those specified in this manual.

### 3.5 - SAFETY PICTOGRAMS

The following safety pictograms may be shown on the equipment and/or packaging PIETRO FIORENTINI S.p.A.:

Symbol	Definition
	Symbol used to identify an ELECTRICAL HAZARD.
	Symbol used to identify a GENERIC HAZARD.

Tab. 3.11.

#### HAZARD!

**It is absolutely forbidden to remove the safety pictograms on the device.**

**The user is obliged to replace safety pictograms which, as a result of wear and tear, removal or tampering are illegible (contact for this PIETRO FIORENTINI S.p.A.).**

### 3.6 - NOISE LEVEL

VS/AM 58 is a safety device with no moving parts.

For the value of the noise generated by the device and further information, contact PIETRO FIORENTINI S.p.A.

#### ATTENTION!

**The obligation to use earmuffs or ear plugs to protect the hearing of qualified professional figures (reference paragraph 2.10) remains in the event that the noise in the installation environment of the device (depending on specific operating conditions) exceeds the value of 85 dBA.**

## 4 - DESCRIPTION AND OPERATION

### 4.1 - GENERAL DESCRIPTION

The relief valves in the VS/AM 58 series are suitable for:

- pre-purified gaseous fluids;
- medium and low pressure systems.

The VS/AM 58 valve is also available as a safety valve.

The main elements of the device are (see Fig. 4.2):

Pos.	Description	Pos.	Description
1	Spring support	5	Seat
2	Setting spring	6	Locking ring nut
3	Sleeve	7	Body
4	Cap	8	Plug

Tab. 4.12.

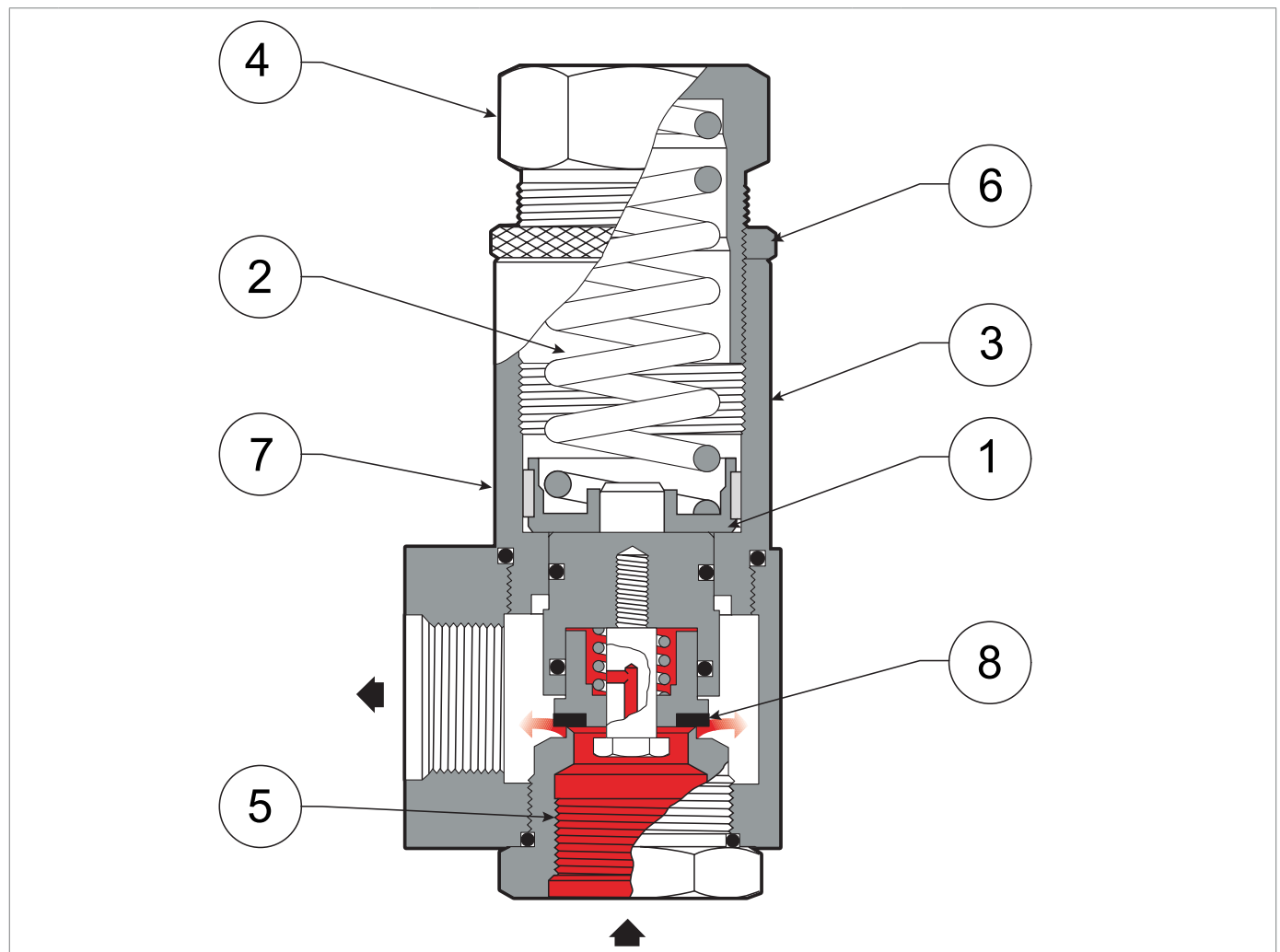

 INLET/OUTLET PRESSURE

Fig. 4.2. General description VS/AM 58

## 4.2 - OPERATION

### ! NOTICE!

**Activation of the VS/AM 58 relief valve involves no external control sources other than the fluid itself.**

The relief valves in the VS/AM 58 series can be installed on both pipelines and pressure vessels.

The pressure at the control point may exceed the calibration pressure due to:

- closing of shut-off valves in a very short time
- gas overheating with zero flow demand

In such cases, relief valves discharge a certain amount of gas to the outside.

Operation is based on the comparison between the thrust on the plug (8) resulting from the upstream pressure ( $P_u$ ) and the thrust resulting from the setting spring (2). The weight of the mobile unit, static thrusts and residual dynamic thrusts on the plug (8) also play a role in this comparison.

If the thrust resulting from gas pressure:

Operating conditions	Operating consequences	Concluding outcome
<b>Overcomes the thrust of the setting spring (2)</b>	Causes the plug (8) to move to the open position	Opening the relief valve VS/AM 58 and pressure relief
<b>Falls below the required calibration value</b>	Causes the plug (8) to move towards the closed position	Closing the relief valve VS/AM 58

Tab. 4.13.

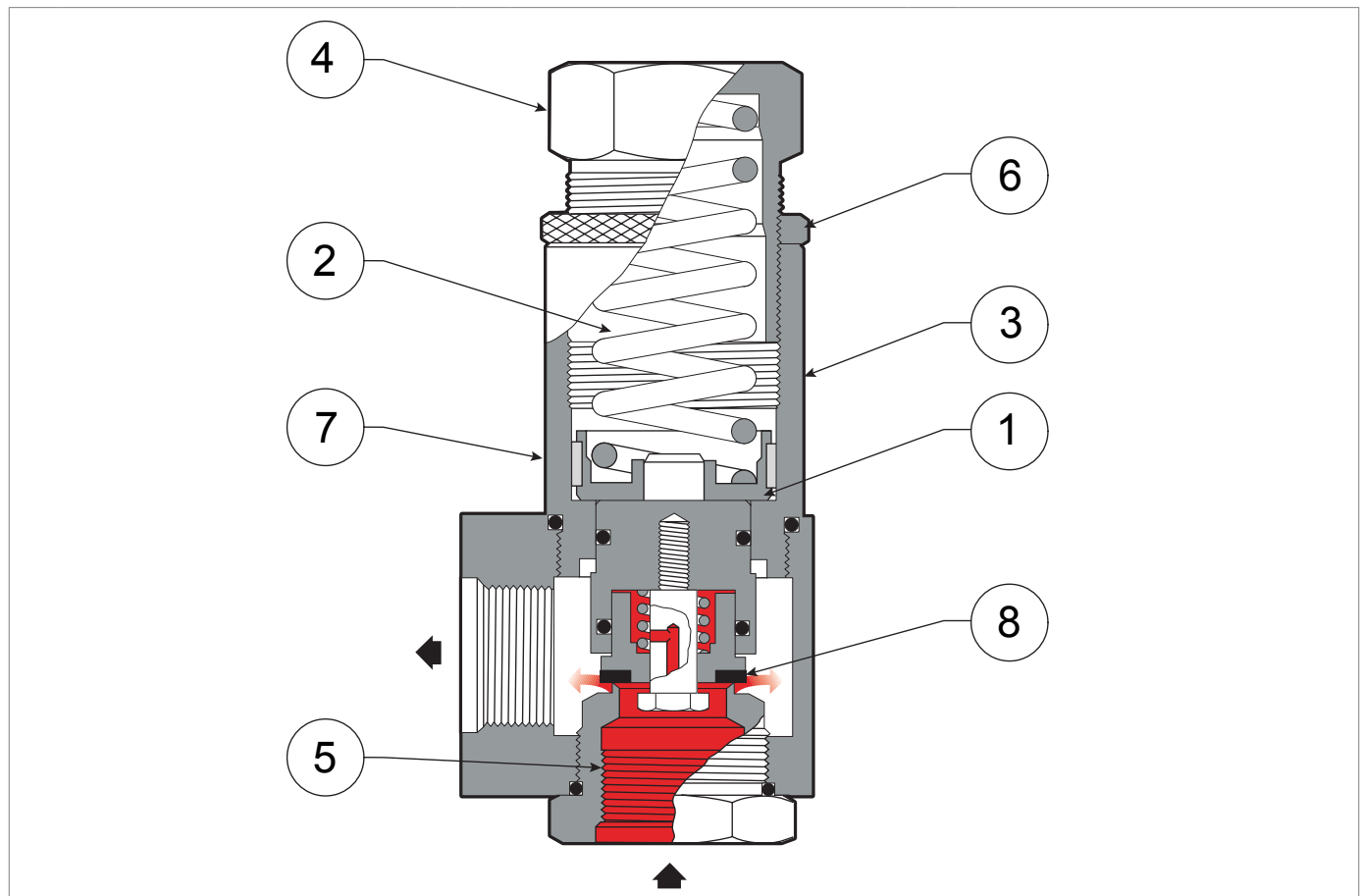

Fig. 4.3. Operation VS/AM 58



## 4.3 - INTENDED USE

### 4.3.1 - ENVISAGED USE

This device is intended for:

Operation	Permitted	Unpermitted	Work environment
<b>Discharge of excess pressure for:</b>	Distribution systems for gaseous, non-aggressive or corrosive fluids, previously filtered.	<ul style="list-style-type: none"> <li>Liquids.</li> <li>Any product other than those permitted.</li> </ul>	Installations for the distribution of gaseous fluids to supply networks for use: <ul style="list-style-type: none"> <li>commercial;</li> <li>domestic.</li> </ul>

Tab. 4.14.

The device referred to was designed to be used exclusively within the limits specified on the nameplate and according to the instructions and limits of use specified in this manual.

Safe work conditions are as follows:

- use within the limits stated on the nameplate and in this manual;
- compliance with the procedures in the manual;
- routine maintenance to be carried out when and how recommended;
- special maintenance to be carried out if required;
- do not tamper with and/or bypass the safety devices.

### 4.3.2 - REASONABLY FORESEEABLE MISUSE

Incorrect and reasonably foreseeable use means the use of the device in a way not foreseen in the phase but which can result from readily foreseeable human behaviour:

- use of the device with corrosive fluids;
- use of the device with fluids that have not been properly treated upstream;
- use of the device with liquids;
- instinctive reaction of an operator in the event of a malfunction, accident or breakdown while using the device;
- behaviour resulting from pressure to keep the machine running under all circumstances;
- behaviour resulting from carelessness;
- behaviour resulting from the use of the device by unauthorised and unsuitable people;
- using the device in a manner other than that referred to under "Intended use".

Any use of the device other than the intended use must be previously approved in writing by PIETRO FIORENTINI S.p.A. If no written approval is provided, use shall be considered improper.

In the event of "improper use", PIETRO FIORENTINI S.p.A. shall not be held liable for any damage caused to people or property, and any type of warranty on the device shall be deemed void.

### 4.3.3 - TYPES OF FLUIDS

The device works with combustible gases used:

- in pressure control stations according to UNI EN 12186:2014 and UNI EN 12279:2007 standards, or in installations carrying LPG;
- in commercial premises and industrial plants (after checking by contacting PIETRO FIORENTINI S.p.A.).

#### NOTICE!

**The device may be also used with inert gases, subject to verification by contacting the manufacturer.**

#### 4.4 - TECHNICAL FEATURES/PERFORMANCE

The main technical features of the device are listed at Tab. 4.15:

Technical features	
<b>Maximum allowable pressure</b>	up to 100 bar
<b>Ambient temperature range</b>	from -20°C to + 60°C
<b>Inlet gas temperature range</b>	from -20°C to + 60°C
<b>Minimum flow rate</b>	up to 1:100
<b>Accuracy</b>	up to 2%
<b>Connections</b>	<ul style="list-style-type: none"> <li>• Threaded according to EN 10226-1</li> <li>• NPT according to ASME B1.20.1</li> <li>• ANSI 300 and 600 according to ASME B16.5</li> </ul>

Tab. 4.15.

## 5 - TRANSPORT AND HANDLING





### 5.1 - SPECIFIC WARNINGS FOR TRANSPORT AND HANDLING

#### NOTICE!

Transport and handling must be carried out in compliance with the regulations in force in the country of installation by personnel who are:

- qualified (specially trained);
- who are familiar with accident prevention and workplace safety regulations;
- authorised to use lifting equipment.

#### Transport and handling

Operator qualification	<ul style="list-style-type: none"> <li>• Installer.</li> </ul>
PPE required	<div style="display: flex; align-items: center;">     </div> <div style="background-color: #f4a460; padding: 5px; margin-top: 5px;">  <b>WARNING!</b> </div> <p>The PPE listed in this table is related to the risk associated with the device. For the PPE required to protect against risks associated with the workplace, installation or operating conditions, please refer to:</p> <ul style="list-style-type: none"> <li>• the regulations in force in the country of installation;</li> <li>• <u>any information provided by the Safety Manager at the installation facility.</u></li> </ul>
Weight and dimensions of the device	For dimensions and weights, please refer to section 5.2 'Physical characteristics of the device'.

Tab. 5.16.

### 5.1.1 - PACKAGING AND FASTENERS USED FOR TRANSPORT

The transport packaging is designed and manufactured to avoid damage during normal transport, storage and handling. The device must be kept in its packaging until installation.

Upon receipt of the device, it is necessary to:

- make sure that no part has been damaged during transport and/or handling;
- immediately report any damage found to PIETRO FIORENTINI S.p.A..

#### NOTICE!

**PIETRO FIORENTINI S.p.A. shall not be liable for any damage to people or property caused by accidents due to failure to comply with the instructions provided in this manual.**

Tab. 5.17 describes the types of packaging used:

Ref.	Type of packaging	Image
A	Single cardboard box	

Tab. 5.17.

### 5.2 - PACKAGING CONTENT

The packaging contains:

#### Description of content

VS/AM 58 gas meter including:

- relief valve;
- installation instructions.

#### NOTICE!

**The technical manual can be downloaded from the manufacturer's website: <https://www.fiorentini.com>**

Tab. 5.18.

## 5.3 - PHYSICAL CHARACTERISTICS OF THE DEVICE

### 5.3.1 - STANDARD VERSION

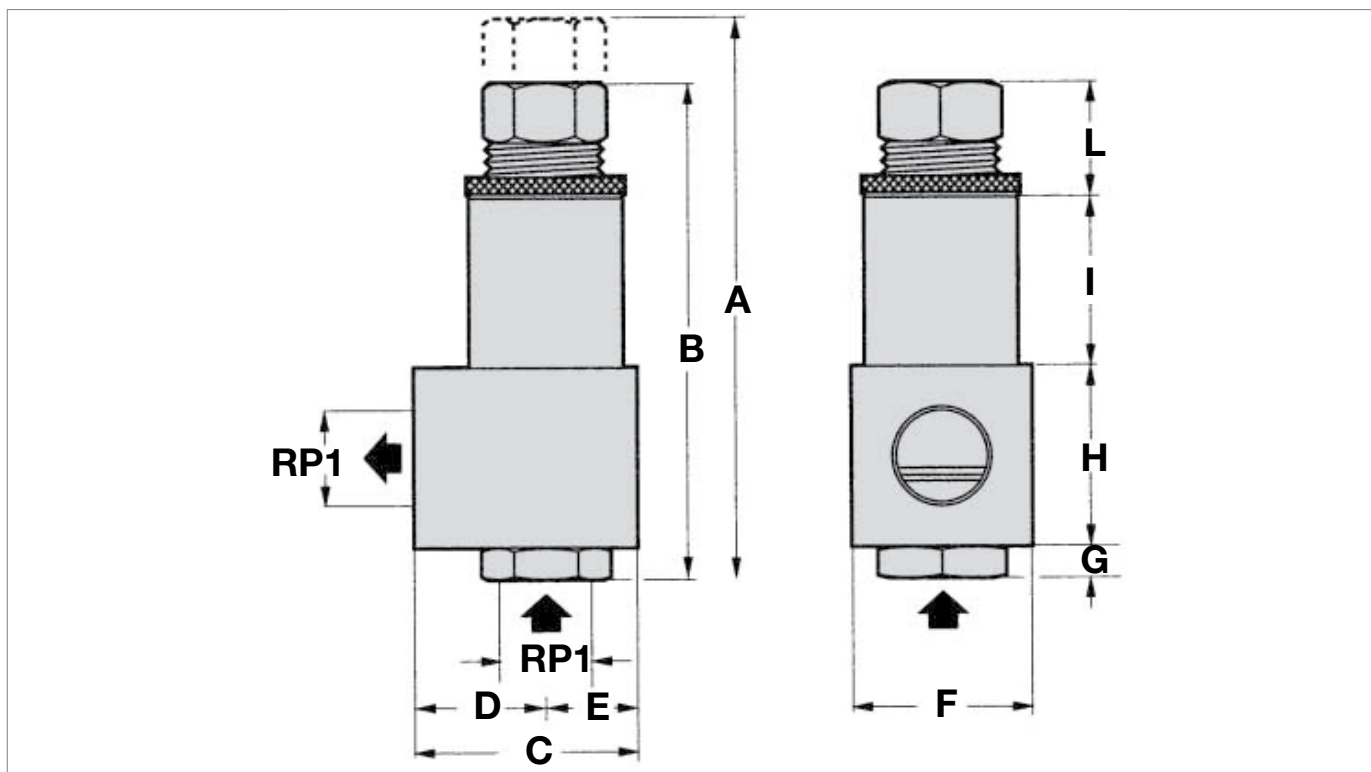

Fig. 5.4. Physical characteristics VS/AM 58 standard version

VS/AM 58 overall dimensions	
Nominal diameter [mm]	25
Size [inches]	1"
A	188
B	155
C	80
D	47
E	33
F	60
G	10
H	60
I	59
L	26

Tab. 5.19.

Weights [kgf]	
Ansi 150	1.9
Ansi 300/600	3.9
RP / NPT	5.6

Tab. 5.20.

### 5.3.2 - FLANGED VERSION

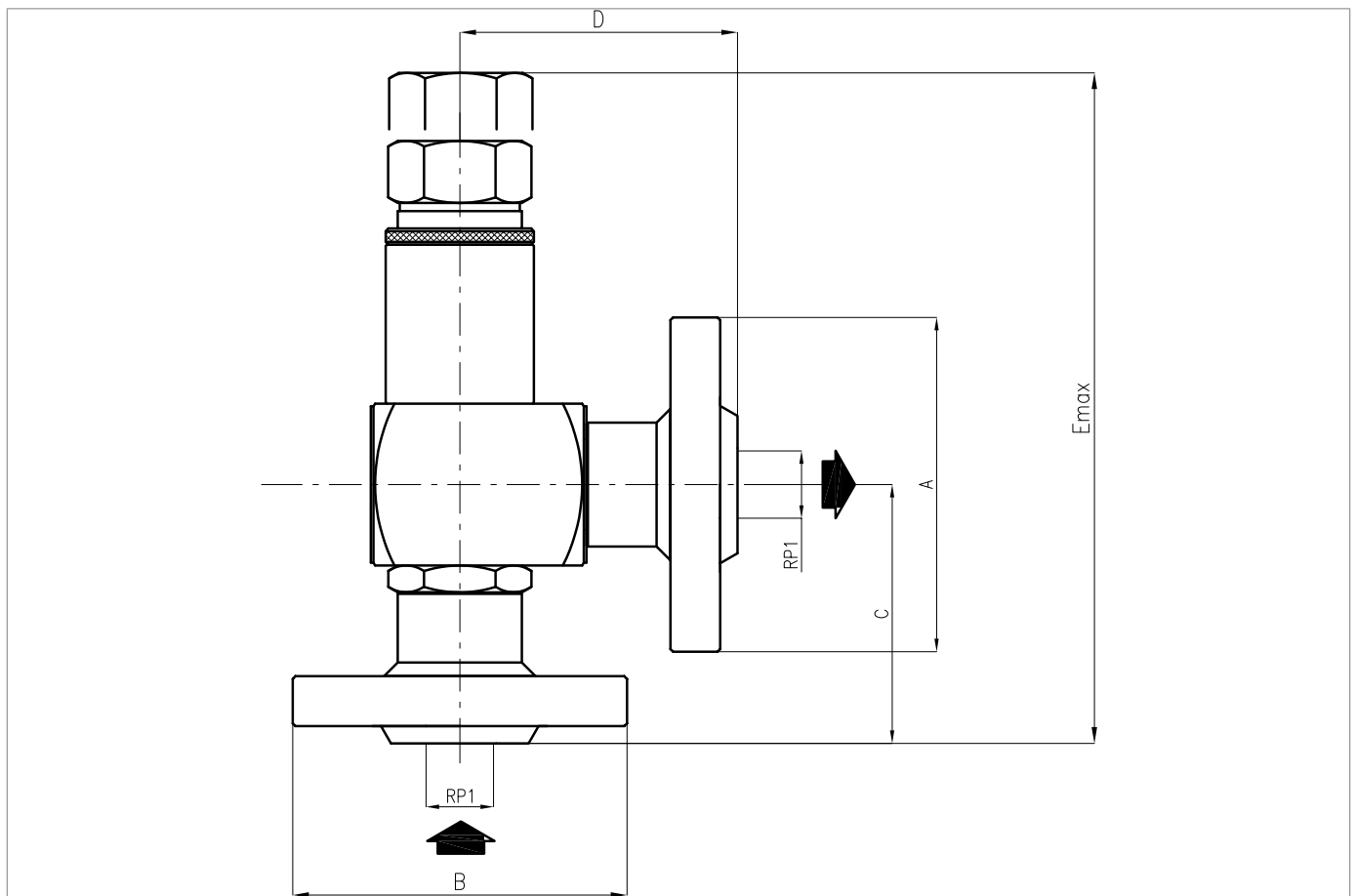

Fig. 5.5. Physical characteristics VS/AM 58 flanged version

VS/AM 58 overall dimensions			
Flanging	ANSI 150	ANSI 300	ANSI 600
A	108	124	124
B	108	124	124
C	76	91	96
D	81	96	101
E	188	203	208
Weight [kg]	3,85	5,58	5,59

Tab. 5.21.

## 5.4 - DEVICE ANCHORING AND LIFTING METHOD

### **HAZARD!**

Using lifting equipment (if necessary) for unloading, carrying and handling packages is reserved only for skilled operators who have been properly trained (and are appropriately qualified if required by the regulations in force in the country of installation) and are familiar with:

- accident prevention rules;
- workplace safety provisions;
- lifting equipment features and limits.

### **HAZARD!**

Before handling a load, make sure that its weight does not exceed the load capacity of the lifting equipment (and any other lifting tools) specified on the specific plate.

### **ATTENTION!**

Before handling the device:

- remove any movable or hanging component or firmly secure it to the load;
- protect fragile equipment;
- check that the load is stable;
- make sure to have perfect visibility along the route.

### 5.4.1 - FORKLIFT HANDLING METHOD

**HAZARD!**

It is forbidden to:





- Do not transit under suspended loads;
- Do not move the load over the personnel operating in the site/plant area.

**WARNING!**

The following is not allowed on forklifts:

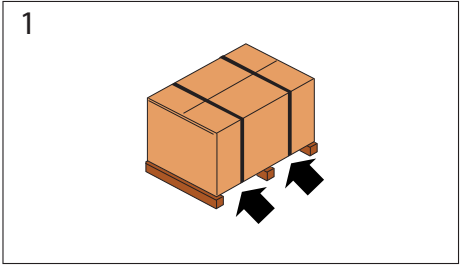
- carrying passengers;
- lifting people.

If cardboard boxes (single or multiple) are carried on a pallet, proceed as indicated in Tab. 5.22:



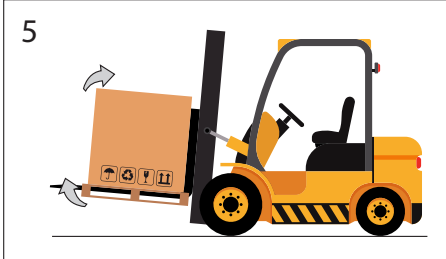

Step	Action	Image
1	Place the forks of the forklift under the load surface.	
2	Make sure that the forks protrude from the front of the load (by at least 5 cm), far enough to eliminate any risk of the transported load tipping.	
3	<p>Raise the forks until they are touching the load.</p> <p><b>NOTICE!</b> Fasten the load to the forks with clamps or similar devices if required.</p>	
4	Slowly lift the load by a few dozen centimetres and check its stability, making sure that the centre of gravity of the load is at the centre of the lifting forks.	



Step	Action	Image
5	Tilt the mast backwards (towards the driver's seat) to help the over-turning moment and to ensure greater load stability during transport.	
6	Adjust transport speed according to the type of floor and load, avoiding sudden manoeuvres. <b>⚠ WARNING!</b> <b>In case of:</b> <ul style="list-style-type: none"> <li>• <b>obstacles along the path;</b></li> <li>• <b>particular operating situations;</b></li> </ul> <b>hinder operator visibility, the assistance of a ground operator is required, standing outside the range of action of the lifting equipment,</b> <b>with the task of signalling.</b>	-
7	Place the load in the chosen installation area.	-

Tab. 5.22.

## 5.5 - PACKAGING REMOVAL

Packaging removal	
Operator qualification	<ul style="list-style-type: none"> <li>Installer.</li> </ul>
PPE required	<div style="display: flex; align-items: center;">     </div> <div style="background-color: #f4a460; padding: 5px; margin-top: 10px;"> <p><b>! WARNING!</b></p> </div> <p>The PPE listed in this table is related to the risk associated with the device. For the PPE necessary to protect against risks associated with the workplace or operating conditions, please refer to:</p> <ul style="list-style-type: none"> <li>the regulations in force in the country of installation;</li> <li><u>any information provided by the Safety Manager at the installation facility.</u></li> </ul>

Tab. 5.23.

To unpack the cardboard boxes (single or multiple) supported by a pallet, proceed as described in Tab. 5.24:

Step	Action
1	Remove the stretch film around the pallet.
2	Remove the 4 support corners.
3	<p>Move the boxes of the equipment from the pallet to their intended place.</p> <div style="border: 1px solid #0070c0; padding: 5px; margin-top: 10px;"> <p><b>! NOTICE!</b></p> <p>Have at least 2 operators manually move the packages if required due to their dimensions/weight.</p> </div>

Tab. 5.24.

<p><b>! NOTICE!</b></p> <p>After removing all packaging materials, check for any anomalies. If there are anomalies:</p> <ul style="list-style-type: none"> <li>do not install the equipment;</li> <li>contact PIETRO FIORENTINI S.p.A. and specify the details provided on the device nameplate.</li> </ul>
---

<div style="background-color: #f4a460; padding: 5px;"> <p><b>! WARNING!</b></p> </div> <p>The individual device is contained in a specially designed cardboard box. Avoid taking the device out of the box before its installation.</p>
---

### 5.5.1 - PACKAGING DISPOSAL

<p><b>! NOTICE!</b></p> <p>Sort the various materials making up the packaging and dispose of them in compliance with the regulations in force in the country of installation.</p>
---

## 5.6 - STORAGE AND ENVIRONMENTAL CONDITIONS

### **WARNING!**

**Protect the regulator from blows and impacts, even accidental, until it is installed.**

The following table shows the minimum environmental conditions to be expected should the device be stored for an extended period.

Compliance with these conditions will guarantee the declared performance:

Conditions	Data
Maximum storage period	5 years.
Temperature	Not above 40°C
Relative humidity	Not above 70%
Radiation and light sources	Away from radiation and light sources according to UNI ISO 2230:2009

Tab. 5.25.

### 5.6.1 - STORAGE LASTING LONGER THAN THE MAXIMUM TIME ALLOWED

#### **NOTICE!**

**After a storage period exceeding the maximum time allowed (5 years), the device must be scrapped.**

## 6 - INSTALLATION

### 6.1 - INSTALLATION PRE-REQUISITES

#### 6.1.1 - ALLOWED ENVIRONMENTAL CONDITIONS

##### **WARNING!**

To safely use the device, in full respect of the allowed environmental conditions, follow the data shown on the regulator plate and on any accessories (refer to paragraph 2.8 “Nameplates applied”).

##### **WARNING!**

The device must be installed away from atmospheric agents and direct sunlight.

The installation site must be suitable for the safe use of the device.

The installation area of the device must be properly lit to ensure proper operator visibility during working on the device.

##### **NOTICE!**

The device must operate in places that are properly lit by artificial lighting suitable for the protection of the operator (in compliance with UNI EN 12464-1:2011 and UNI EN 12464-2:2014). If work is to be performed in areas and/or parts that are poorly lit, it is mandatory to:

- use the light sources of the installation plant;
- be equipped with a handheld lighting system or connected to the power mains, compliant with Directive 2014/34/EU (ATEX) for use in environments at risk of explosion.

#### 6.1.2 - STORAGE LASTING LONGER THAN THE MAXIMUM TIME ALLOWED

##### **WARNING!**

It is forbidden to install the device after a storage period exceeding the maximum permitted (5 years).

After a storage period longer than the maximum permitted, the device must be scrapped.

### 6.1.3 - CHECKS BEFORE INSTALLATION

The device does not require any further upstream safety device for protection against any overpressure with respect to its **PS admissible pressure** when, for the upstream reduction station, the maximum incidental downstream pressure is:

$$\text{MIPd} \leq 1.1 \text{ PS}$$

**MIPd** = Maximum incidental downstream pressure value (for further information, see UNI EN 12186:2014).

#### **WARNING!**

**Identify the model of the device by means of the applied identification plate (see section 2.8) and ensure that the data on it agrees with the required performance.**

#### **ATTENTION!**

**The installer must use fittings and gaskets recommended by the manufacturer.**

**If the installation of the device requires the application of compression fittings, these must be installed in accordance with the instructions of the Manufacturer of the fittings themselves.**

**The choice of fittings must be compatible with:**

- **use for a specific device;**
- **the plant specifications when required.**

Before installation, it must be ensured that:

- the installation is constructed in accordance with the standards in force and in any case according to good engineering practice;
- the device has not been damaged during transport;
- the intended installation compartment meets the provisions in force on safety and is away from any possible damage of mechanical origin, away from sources of heat or naked flames, in a dry place and protected from external agents;
- the device can be inserted in the space provided (see section 5.3 'Physical characteristics of the device');
- there are no obstructions that could hinder installation operations and the future maintenance operations;
- the inlet and outlet pipes are at the same level and able to support the weight of the device (see section 5.3 "Physical characteristics of the device");
- on the input/output connections are totally free of mechanical stress;
- the pipe inlet/outlet connections are parallel and clean;
- the inlet piping has been cleaned in order to expel residual impurities such as welding slag, sand, paint residues, water, etc.

## 6.2 - SPECIFIC SAFETY INSTRUCTIONS FOR THE INSTALLATION STEP

### **WARNING!**

Before proceeding with installation, make sure that the upstream and downstream valves installed on the line are shut off.

### **WARNING!**

Installation may also take place in areas where there is a risk of explosion, which implies that all necessary prevention and protection measures have to be taken.

For these measures, please refer to the regulations in force at the place of installation.

### **WARNING!**

In the vicinity of the device it is prohibited to:

- use open flames (e.g. for welding operations);
- smoke.

### **WARNING!**

When installing the device:

- in closed rooms, all body and cover drains must be connected and led to the outside;
- outdoors, it must be protected from the weather and direct sunlight.

### **WARNING!**

The device is designed to operate under atmospheric backpressure (backpressure = 0).

It is the responsibility of the system designer to correctly dimension the discharge line downstream of the device in accordance with the design conditions.

### **WARNING!**

The installer must use fittings and gaskets recommended by PIETRO FIORENTINI S.p.A.

### **WARNING!**

In order to avoid breakage or unwanted deformation, it is necessary to:

- install the device according to current standards;
- that there are no external loads bearing on the device;
- do not use the device as a template (can be supplied on request);
- to provide the device with appropriate protective means and earthing against stray currents and potential electrostatic differentials;
- use the device within the limits indicated on the identification plates attached to it (see section 2.8 of the manual).

### 6.3 - POSSIBLE INSTALLATIONS OF THE DEVICE

**NOTICE!**

- With natural gas or other non-corrosive gases that are not subject to recondensation, the device can be installed in any flow direction.
- Please avoid any mounting positions with outlet flow facing upwards in installations using LPG.

For information about how to mount the device in keeping with the available models and configurations, refer to Tab. 6.26:

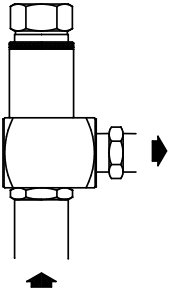
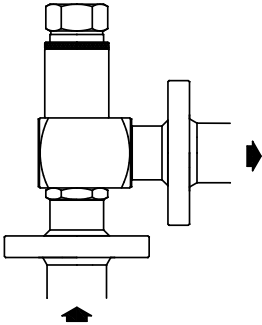
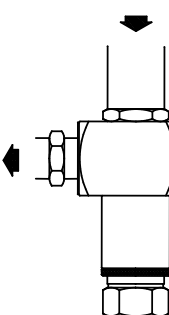
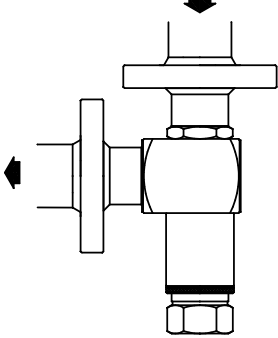
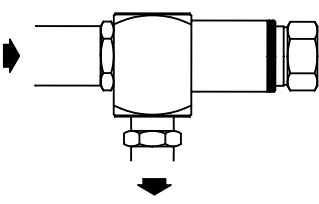
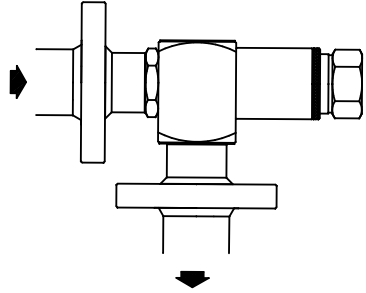
Flow direction	Installation position version without flanges   flanged version	
Square horizontal flow		
Square reverse vertical flow		
Square vertical flow		

Tab. 6.26.

## 6.4 - INSTALLATION PROCEDURE

Installation	
Operator qualification	<ul style="list-style-type: none"> <li>Installer.</li> </ul>
PPE required	<div style="display: flex; align-items: center;">  </div> <div style="background-color: #e67e22; color: white; padding: 5px; margin-top: 5px;"> <b>⚠ WARNING!</b> </div> <p>The PPE listed in this table is related to the risk associated with the device. For the PPE required to protect against risks associated with the workplace, installation or operating conditions, please refer to:</p> <ul style="list-style-type: none"> <li>the regulations in force in the country of installation;</li> <li><u>any information provided by the Safety Manager at the installation facility.</u></li> </ul>
Equipment required	Refer to Chapter 7 'Commissioning/maintenance equipment'.

Tab. 6.27.

The device must be installed on the line with the arrow on the body pointing in the direction of gas flow.

**⚠ WARNING!**

**Install the device taking into consideration that the direction of flow is required and is indicated with an arrow on the body of the device itself.**

**! NOTICE!**

**Clean the pipes before installing the device.**



### 6.4.1 - DEVICE INSTALLATION PROCEDURE

To install the device inline, proceed as indicated at Tab. 6.28:

Step	Action
1	Apply the checks in paragraph 6.1.3 (“Checks before installation”).
2	Remove all packaging/protection of the device (if any). <b>NOTICE!</b> <b>For proper disposal of packaging, please refer to the regulations in force in the country where the equipment is installed.</b>
3	Position the device in the section of the line intended for it.
4	Make the connection (see Fig. 6.5).
5	Check that the inlet/outlet shut-off valves, the bypass valve, if any, and the air vent valve are closed.

Tab. 6.28.

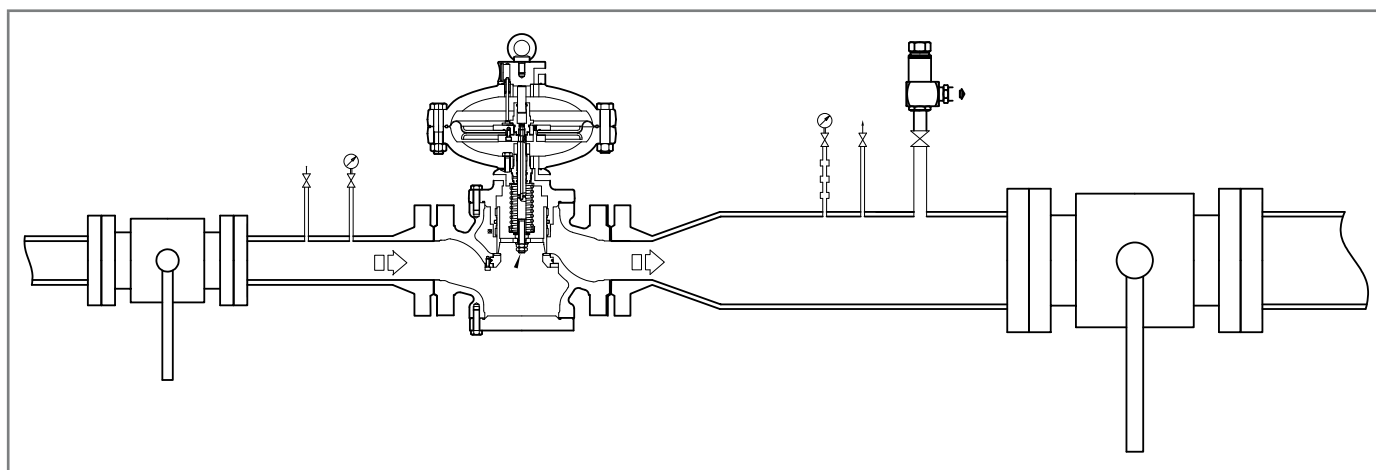

Fig. 6.6. Installation scheme

#### **NOTICE!**

The warranty shall be deemed null and void and PIETRO FIORENTINI S.p.A. shall not be held liable for any damage and/or malfunctions if the fittings used during installation are not those supplied.

### 6.5 - POST-INSTALLATION CHECKS

To perform the post-installation check, proceed as shown in Tab. 6.29:

Step	Action
1	Sprinkle the device and its connections to the system with a foaming solution or similar.
2	Open the shut-off valve at the inlet of the device very slowly.
3	Check that the shut-off valve does not start to discharge.
4	Check the tightness of the internal and external surfaces of the device, verifying that the foaming solution does not change in the form of swelling or bubbles.

Tab. 6.29.

#### **WARNING!**

Protect the device from blows and shocks, even accidental ones, until commissioning.



## 7 - COMMISSIONING/MAINTENANCE EQUIPMENT

### 7.1 - LIST OF EQUIPMENT

Use of commissioning/maintenance equipment	
<b>Operator qualification</b>	<ul style="list-style-type: none"> <li>Name of the user.</li> <li>Specialised technician.</li> </ul>
<b>PPE required</b>	<div style="display: flex; align-items: center;">  </div> <div style="background-color: #f4a460; padding: 5px; margin-top: 5px;"> <b>⚠ WARNING!</b> </div> <p>The PPE listed in this table is related to the risk associated with the device. For the PPE required to protect against risks associated with the workplace, installation or operating conditions, please refer to:</p> <ul style="list-style-type: none"> <li>the regulations in force in the country of installation;</li> <li>any information provided by the Safety Manager at the installation facility.</li> </ul>

Tab. 7.30.

We list the types of equipment required for commissioning and maintenance of the regulator:

Ref.	Equipment type	Image
<b>A</b>	13-12 mm tubular socket wrench	
<b>B</b>	Sleeve spanner	
<b>C</b>	Valve seat spanner	

Tab. 7.31.

## 8 - COMMISSIONING

### 8.1 - GENERAL WARNINGS

#### 8.1.1 - SAFETY REQUIREMENTS FOR COMMISSIONING

##### HAZARD!

During commissioning the risks associated with any discharges to the atmosphere of flammable or noxious gases must be evaluated.

##### HAZARD!

In case of installation on distribution networks for natural gas, consider the risk associated with explosive mixtures (gas/air) being formed inside the piping, if the line is not subjected to inerting.

##### WARNING!

During commissioning, any unauthorised personnel must keep away.  
The no entry area has to be marked with signs and/or boundaries.

##### NOTICE!

Commissioning has to be carried out by authorised and qualified personnel.

The equipment is supplied with the pressure switch / control device already calibrated.



##### NOTICE!

It is possible that for various reasons (e.g. vibrations during transport) the calibration of the equipment's accessories may vary, although within the values indicated on the identification plates.

Before commissioning the equipment, it is necessary to check that:

- all shut-off valves (inlet, outlet, any bypass) are closed;
- the gas is at a temperature within the limits specified on the data plate.

#### Commissioning

<b>Operator qualification</b>	<ul style="list-style-type: none"> <li>• Installer;</li> <li>• Qualified technician.</li> </ul>
<b>PPE required</b>	<div style="display: flex; align-items: center;">  </div> <div style="background-color: #f96; padding: 5px; margin-top: 5px;">  <b>WARNING!</b> </div> <p>The PPE listed in this table is related to the risk associated with the equipment. For the PPE required to protect against risks associated with the workplace, installation or operating conditions, please refer to:</p> <ul style="list-style-type: none"> <li>• the regulations in force in the country of installation;</li> <li>• <u>any information provided by the Safety Manager at the installation facility.</u></li> </ul>
<b>Equipment required</b>	Please refer to the chapter "7 - Commissioning/maintenance equipment".

Tab. 8.32

## 8.2 - PRELIMINARY PROCEDURES FOR COMMISSIONING

### HAZARD!

Before commissioning the equipment, it must be ensured that any source of explosion has been eliminated if there is such a danger.

### WARNING!

Before commissioning, you need to make sure that the characteristics of the equipment are suitable for the conditions of use.

### ATTENTION!

To protect the equipment from damage, never:

- pressurise the equipment through a valve located downstream of it;
- depressurise the equipment through a valve located upstream of it.

Commissioning can be carried out using two different procedures:

### Commissioning types

<b>Injection of an inert fluid</b>	Pressurising the equipment by injecting an inert fluid (e.g. nitrogen) to avoid potentially explosive mixtures for services with combustible gases. <div style="background-color: #f4a460; padding: 5px;"><b> WARNING!</b></div> <b>During pressurisation, always check that the equipment has no leaks.</b>
<b>Direct injection</b>	Direct injection of gas into pipes, keeping the gas velocity in the pipes as low as possible (maximum permitted value of 5 m/s).

Tab. 8.33

### 8.3 - PROPER COMMISSIONING CHECK

Completely sprinkle the equipment with a foaming solution (or equivalent control system) in order to check the tightness of the external surfaces of the regulator and the connections made during the installation.

### 8.4 - CALIBRATION OF EQUIPMENT AND ACCESSORIES INSTALLED

 **NOTICE!**

To properly calibrate the equipment and accessories present, refer to the accuracy class indicated on the nameplates (see section “2.8 - Applied rating plates”).

**8.5 - RELIEF VALVE COMMISSIONING PROCEDURE VS/AM 58**

**8.5.1 - WITH EXTERNAL PRESSURE SOURCE**

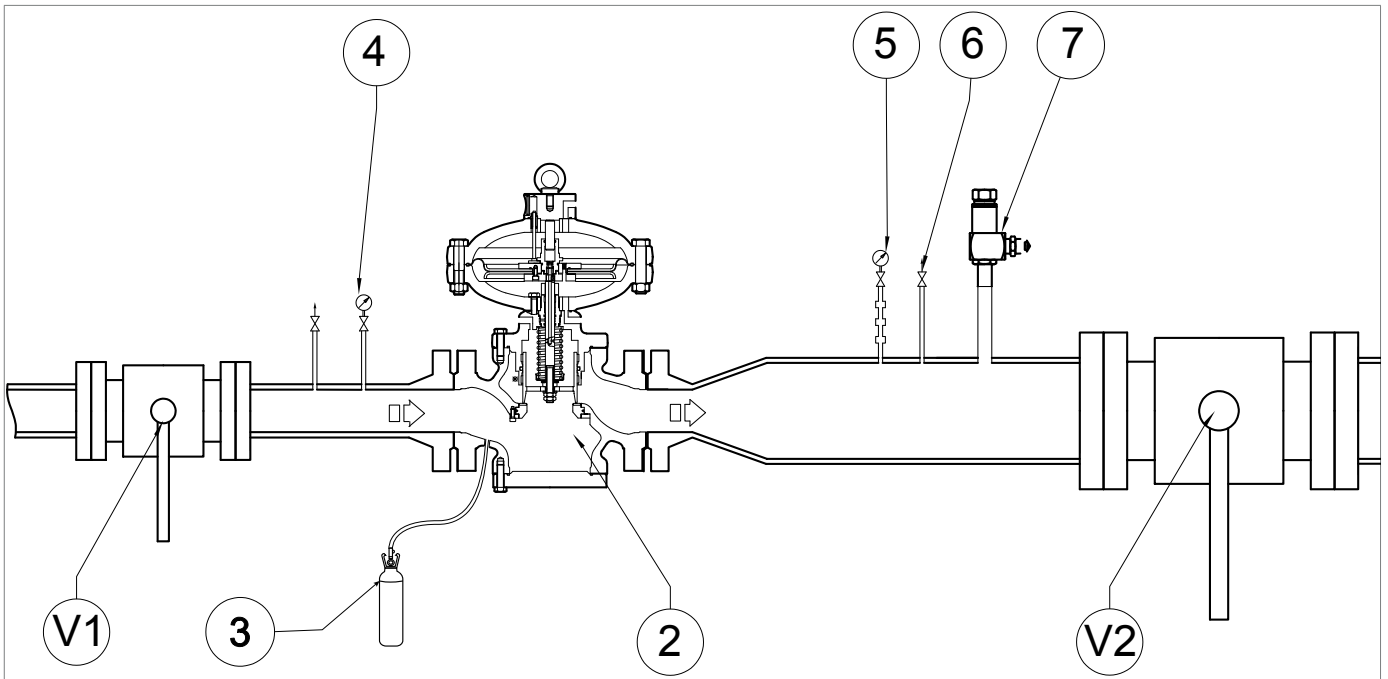

Fig. 8.7. Commissioning VS/AM 58 with shut-off valve

Step	Action
1	Check that the upstream (V1) and downstream (V2) shut-off valves are closed.
2	Partially open the bleed cock (6).
3	Disconnect the downstream pipe connected to the relief valve (7).
4	Connect the external source (3) upstream of the equipment (2). <b>NOTICE!</b> <b>Check the pressure referring to the upstream pressure gauge (4).</b>
5	Open the equipment (2).
6	Using the external source (3), increase the upstream pressure (Pu) to the required setting value of the relief valve (7). <b>NOTICE!</b> <b>Check the pressure referring to the downstream pressure gauge (5).</b>
7	Check the trip calibration setting of the relief valve (7): <ul style="list-style-type: none"> <li>• turn clockwise to increase calibration</li> <li>• turn anti-clockwise to decrease calibration</li> </ul>
8	Decrease the upstream pressure value (Pu) via the external source (3).
9	Close the bleed cock (6).
10	Check the tightness at the outlet connection of the relief valve (7). <b>NOTICE!</b> <b>In the event of leaks, service the relief valve (7) (see par. 9.4.4).</b>
11	Open the bleed cock (6).
12	Close the equipment (2).
13	Disconnect the external source (3) from the equipment (2).
14	Reconnect the downstream pipe to the relief valve (7).
15	Slowly open the upstream shut-off valve (V1).
16	Close the bleed cock (6).
17	Open the downstream shut-off valve (V2) very slowly until the piping has been filled completely. <b>NOTICE!</b> <b>Check the pressure referring to the downstream pressure gauge (5).</b>

Tab. 8.34

## 8.5.2 - WITHOUT EXTERNAL PRESSURE SOURCE

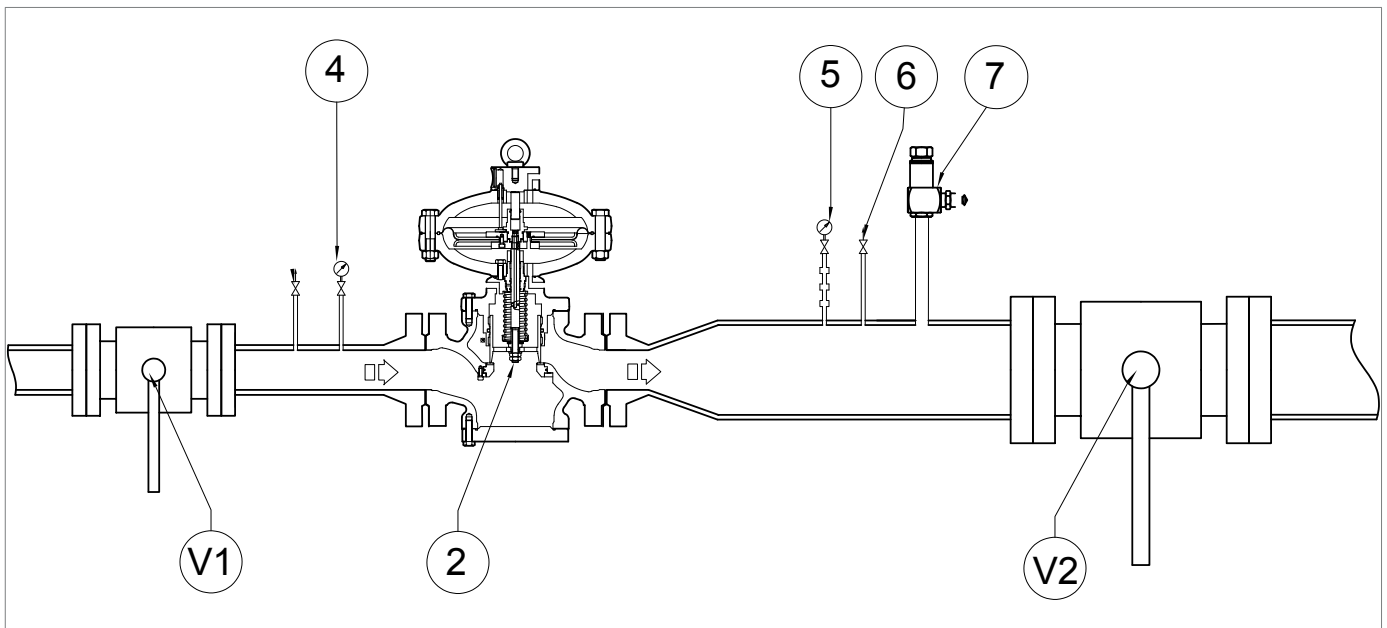

Fig. 8.8. Relief valve commissioning VS/AM 58 without shut-off valve

Step	Action
1	Close the downstream shut-off valve (V2).
2	Disconnect the downstream pipe connected to the relief valve (7).
3	Increase the upstream pressure ( $P_u$ ) of the relief valve (7) to the required setting value: <ul style="list-style-type: none"> <li>• for direct-acting regulators: by turning the adjusting screw clockwise</li> <li>• for pilot-operated regulators: by turning the pilot adjustment screw clockwise</li> </ul>
4	Check the trip calibration setting of the relief valve (7): <ul style="list-style-type: none"> <li>• turn clockwise to increase calibration</li> <li>• turn anti-clockwise to decrease calibration</li> </ul>
5	Decrease the upstream pressure value ( $P_u$ ) of the relief valve (7): <ul style="list-style-type: none"> <li>• for direct acting regulators: by turning the adjusting screw anti-clockwise</li> <li>• for pilot-operated regulators: by turning the pilot adjustment screw anti-clockwise</li> </ul>
6	Repeat steps 3-4-5 at least three times. <div style="border: 1px solid black; padding: 5px; margin-top: 5px;"> <p><b>! NOTICE!</b> The calibration value must comply with the operating limits specified on the plate.</p> </div>
7	Check the tightness at the outlet connection of the relief valve (7). <div style="border: 1px solid black; padding: 5px; margin-top: 5px;"> <p><b>! NOTICE!</b> In the event of leaks, service the relief valve (7) (see par. 9.4.4)</p> </div>
8	Reconnect the downstream pipe.
9	Return the regulator (2) to the preset calibration value.
10	Open the downstream shut-off valve (V2) very slowly.

Tab. 8.35



## 9 - MAINTENANCE AND FUNCTIONAL CHECKS

### 9.1 - GENERAL WARNINGS

#### HAZARD!

- Maintenance work must be carried out by qualified personnel trained on safety in the workplace and authorised to carry out device-related activities.
- Repair or maintenance work not provided for in this manual may be carried out only if approved by PIETRO FIORENTINI S.p.A.. PIETRO FIORENTINI S.p.A. shall not be held liable for damage to persons or property resulting from operations other than those described herein or carried out in ways other than as indicated.

#### WARNING!

Before conducting any work, make sure that the line on which the device is installed:

- has been shut off downstream and upstream;
- has been discharged.

#### WARNING!

When depressurising the system for maintenance operations, care must be taken to ensure that the vents to the outlets are in a safe area.

To avoid the risk of spark generation due to the impact of impurity particles within the discharge lines, it is recommended to maintain a fluid velocity of less than 5 m/sec.

#### WARNING!

In case of doubt, do not perform any work. Contact PIETRO FIORENTINI S.p.A. for the necessary clarifications.

The management and/or use of the device includes interventions that are necessary as a result of normal use such as:

- inspection and checks;
- functional checks;
- routine maintenance;
- special maintenance.

#### NOTICE!

Maintenance work is strictly related to:

- the quality of the conveyed gas (impurities, humidity, gasoline, corrosive substances);
- the state of cleanliness and preservation of the pipes upstream of the device;
- the level of reliability required of the installation;
- to the conditions of use of the device.

Good device management requires:

- follow the service frequency referred to in the manual for functional checks and routine maintenance.
- not exceed the time interval between one service and the next. The time interval is to be understood as the maximum acceptable; it can, however, be shortened;
- promptly check the causes of any anomalies such as excessive noise, leakage of fluids or similar and remedy them. The timely removal of any causes of anomaly and/or malfunction prevents further damage to the equipment and ensures operator safety;

Before beginning disassembly of the device, make sure that:

- the spare parts and parts used in replacements have adequate requirements to ensure the original performance of the device. Use recommended original spare parts;
- the operator has the necessary equipment (see chapter 7 “Equipment for commissioning/maintenance”).

 **NOTICE!**

**The recommended spare parts are unambiguously identified with tags indicating:**

- **the assembly drawing number of the device where they are installed (see Chapter 12 “Recommended spare parts”);**
- **the position specified in the assembly drawing of the device.**

The device maintenance operations are divided, from an operational point of view, into three main categories:

Commissioning and maintenance operations	
<b>Periodic checks and inspections</b>	All those checks that the operator must carry out on a regular basis to ensure that the device is in proper working order.
<b>Routine maintenance</b>	All those operations that the operator must preventively carry out to ensure proper operation of the device over time. Routine maintenance includes: <ul style="list-style-type: none"> <li>• inspection;</li> <li>• control;</li> <li>• adjustment;</li> <li>• cleaning;</li> <li>• lubrication;</li> <li>• replacement of all spare parts.</li> </ul>
<b>Special maintenance</b>	<p>All those operations to be carried out by the operator when the device requires them.</p> <div style="background-color: #c00000; color: white; padding: 5px; display: flex; align-items: center;">  <b>HAZARD!</b> </div> <p><b>Special maintenance:</b></p> <ul style="list-style-type: none"> <li>• <b>requires extensive and specialised knowledge of the machines, operations required, risks involved and correct procedures to operate safely;</b></li> <li>• <b>must be provided by qualified, trained and authorised technicians.</b></li> </ul>

Tab. 9.36.

## 9.2 - PERIODICALLY CHECKING AND INSPECTING THE EQUIPMENT FOR PROPER OPERATION

Periodic checks and inspections	
<b>Operator qualification</b>	Mechanical maintenance technician
<b>PPE required</b>	 <p><b>WARNING!</b></p> <p>The PPE listed in this table is related to the risk associated with the equipment. For the PPE required to protect against risks associated with the workplace, installation or operating conditions, please refer to:</p> <ul style="list-style-type: none"> <li>the regulations in force in the country of installation;</li> <li>any information provided by the Safety Manager at the installation facility.</li> </ul>

Tab. 9.37

Tab. 9.38 lists checks and verifications, i.e. operations that do not require any manual intervention on the individual equipment.

Some items thereof can be replaced remotely using suitable remote control tools. The following is listed below:

Activity description	Equipment/accessories involved	Evaluation criterion	Minimum frequency
<b>Significant performance check*</b>	Pressure regulators	<ul style="list-style-type: none"> <li>No fluctuations in the adjusted pressure.</li> <li>Significant pressure values within pre-set limits.</li> </ul>	Monthly
	Gas flow slam-shut type safety devices (external position indicator)	<ul style="list-style-type: none"> <li>Fully open position.</li> </ul>	
	Stand-by monitor (external position indicator)	<ul style="list-style-type: none"> <li>Fully open position.</li> </ul>	
<b>Visual inspection of the equipment outside condition</b>	All	<ul style="list-style-type: none"> <li>No visible damage.</li> <li>External surface protection as per UNI 9571-1:2012.</li> </ul>	Half-yearly

Tab. 9.38

\* These checks may be carried out remotely if there is a remote control system capable of analysing the significant performance of the equipment and of sending alerts/alarms when pre-set thresholds are reached.

## 9.3 - ROUTINE MAINTENANCE

### 9.3.1 - GENERAL SAFETY WARNINGS

#### HAZARD!

- Put the device in a safe condition (close the downstream and then the upstream shut-off valve, drain the device completely and lastly drain the line);
- Ensure that the pressure upstream and downstream of the device is “0”.

#### NOTICE!

Before installing new sealing elements (o-rings, diaphragm, etc.), they must be checked for integrity.

### 9.3.2 - REPLACEMENT FREQUENCY FOR COMPONENTS SUBJECT TO WEAR

#### NOTICE!

The following provisions shall apply to device components only.

The non-metallic parts of the equipment concerned are divided into the following two categories:

#### Preventive maintenance work

<b>Category 1</b>	Covers parts subject to wear and/or abrasion, where: <ul style="list-style-type: none"> <li>• wear and tear means the normal degradation of a part after prolonged use under normal operating conditions;</li> <li>• abrasion is the mechanical action on the surface of the affected part resulting from the passage of gas under normal operating conditions.</li> </ul>
<b>Category 2</b>	takes into account parts subject to aging only, including parts that also require lubrication and/or cleaning.

Tab. 9.39.

#### NOTICE!





Check the state of wear/abrasion/ageing of the components present within the minimum frequency indicated in the table below.

Category	Part description	Evaluation criterion	Minimum replacement frequency
1	Sealing rings for non-metallic valve seats and plugs.	Pressure regulators	6 years
		Safety devices	
		Pressure safety system equipment	
1	Non-metallic parts with internal sealing function of valve seats and accessories of individual equipment.	Pilots	6 years
		Pre-regulators	
		Accelerators	
1	Non-metallic parts with a sealing function between parts, at least one of which is in motion under normal working/operating conditions.	Pressure regulators	6 years
		Gas flow slam-shut type safety devices	
		Relief devices with discharge to atmosphere	

Category	Part description	Evaluation criterion	Minimum replacement frequency
1	Non-metallic parts with sealing function involved in disassembly operations during maintenance.	Equipment subject to maintenance	6 years
2	Non-metallic parts providing feedback (sensing elements) of the controlled pressure of safety equipment.	Safety equipment and/or accessories	6 years
2	Non-metallic parts with sealing and performance functions (diaphragms).	Pressure regulators and accessories	6 years
		Gas flow slam-shut type safety devices	6 years
		Relief device with discharge to atmosphere	6 years
2	Non-metallic parts of equipment with an internal sealing function: under normal operating conditions during maintenance.	Relief valves	6 years
		Regulation lines disconnection equipment	If there are proven leaks
2	Non-metallic parts with a static sealing function only.	Various equipment	If there are proven leaks
2	Lubricating parts.	Shut-off valves	Yearly
		Other equipment	Yearly
2	Filter elements.	Filters	As needed

Tab. 9.40.

## 9.4 - ROUTINE MAINTENANCE PROCEDURES

Routine maintenance	
Operator qualification	<ul style="list-style-type: none"> <li>User/specialist technician.</li> </ul>
PPE required	<div style="display: flex; align-items: center;">      </div> <p><b>WARNING!</b></p> <p>The PPE listed in this table is related to the risk associated with the device. For the PPE required to protect against risks associated with the workplace, installation or operating conditions, please refer to:</p> <ul style="list-style-type: none"> <li>the regulations in force in the country of installation;</li> <li><u>any information provided by the Safety Manager at the installation facility.</u></li> </ul>
Equipment required	Refer to Chapter 7 'Commissioning/maintenance equipment'.

Tab. 9.41.

### 9.4.1 - PRELIMINARY OPERATIONS

#### **HAZARD!**

- Put the device in a safe condition (close the downstream and then the upstream shut-off valve, drain the device completely and lastly drain the line);
- Ensure that the pressure upstream and downstream of the device is "0".

### 9.4.2 - DISASSEMBLY/REASSEMBLY

#### **NOTICE!**

Make reference marks, before disassembly, on parts of the device which may present orientation or mutual positioning problems during reassembly.

#### **WARNING!**

Handle the internal components of the device with extreme care in order not to damage them. If any components are damaged during disassembly and reassembly, replace them.

### 9.4.3 - REPLACING ELEMENTS SUBJECT TO WEAR AND ABRASION

#### 9.4.3.1 - INITIAL OPERATIONS

**! ATTENTION!**

Before carrying out any work, it is important to ensure that the line on which the regulator is installed has been shut off upstream and downstream, and discharged.

**! ATTENTION!**

During assembly, make sure to tighten the screws as per the tables (tightening torques), according to the size for which maintenance is being carried out.

#### 9.4.3.2 - CROSS DIAGRAM FOR TIGHTENING SCREWS

To tighten the screws, when required by the maintenance procedure, refer to the following diagram:

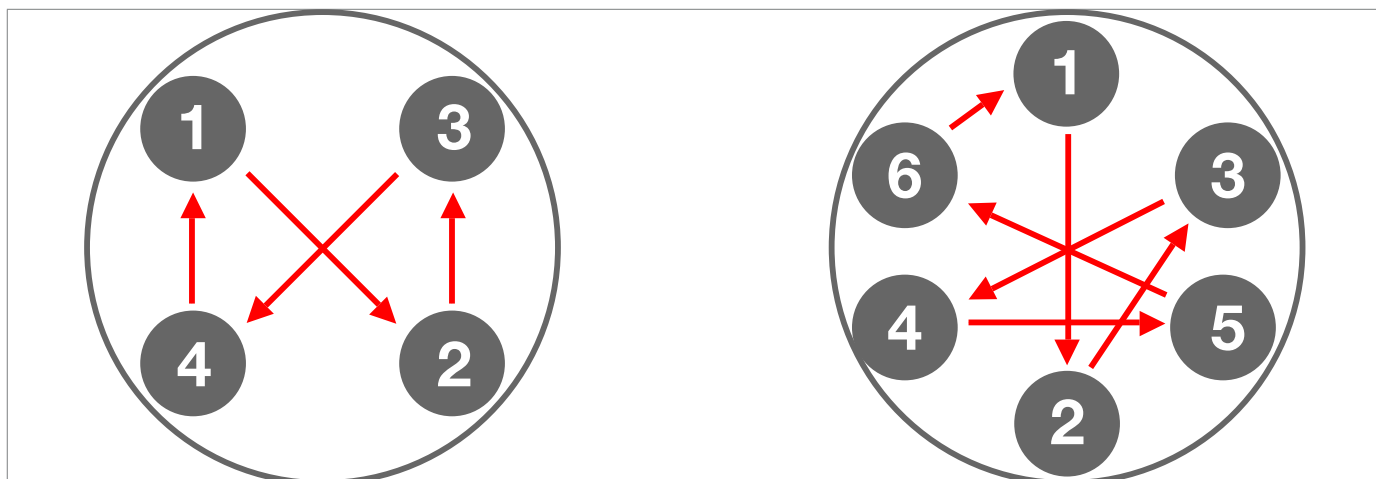

Fig. 9.9. Cross diagram

**9.4.4 - RELIEF VALVE MAINTENANCE PROCEDURE VS/AM 58**

**9.4.4.1 - VS/AM 58 FLANGED VERSION**

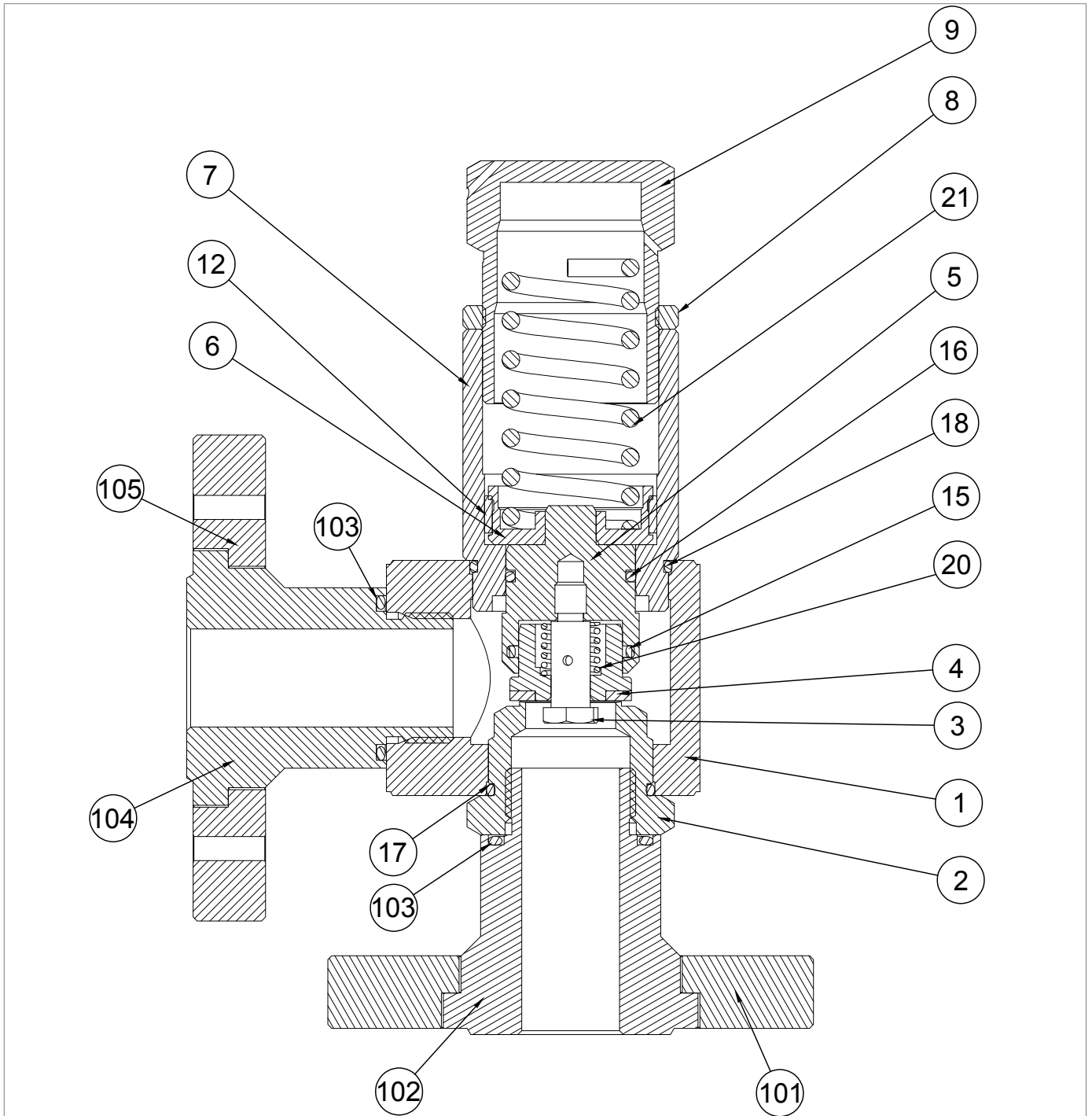







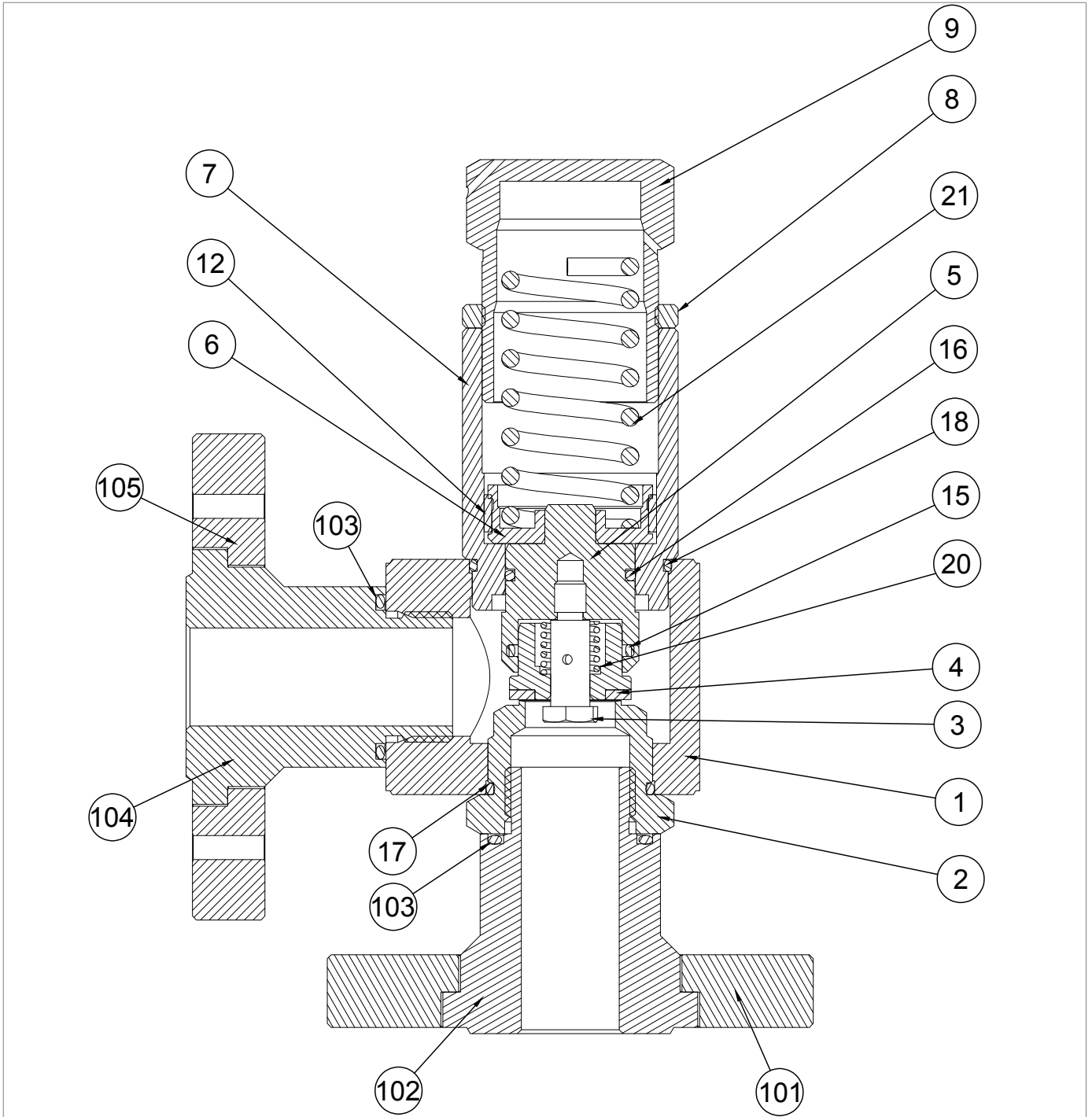

Fig. 9.10. VS/AM 58 flanged version



Step	Action
1	Unscrew and remove the cap (9) together with the ring nut (8).
2	Remove the spring (21) together with the spring holder (6).
3	Unscrew the sleeve (7) together with the plug guide (5) and the I/DWR ring (12) from the body (1). Remove the I/DWR ring (12) and replace it, taking care to lubricate it with synthetic grease.
4	 <b>NOTICE!</b> <b>Before inserting the replacement I/DWR ring, clean the retaining slots with a cleaning solution.</b>
5	Separate the plug guide (5) from the sleeve (7).
6	Remove the O-ring (16) from the plug guide (5) and replace it, taking care to lubricate it with synthetic grease.  <b>NOTICE!</b> <b>Before inserting the replacement O-ring, clean the retaining slots with a cleaning solution.</b>
7	Undo and remove the screw (3).
8	Remove the gasket (4).
9	Remove the spring (20).
10	Remove the O-ring (15) and replace it, taking care to lubricate it with synthetic grease.  <b>NOTICE!</b> <b>Before inserting the replacement O-ring, clean the retaining slots with a cleaning solution.</b>
11	Insert the spring (20) together with the replacement gasket (4) into the plug guide (5).
12	Insert and fix the screws (3).
13	Unscrew and remove the downstream fitting (104) together with the downstream flange (105).
14	Remove and replace the O-ring (103) from the downstream fitting (104), lubricating it with synthetic grease.  <b>NOTICE!</b> <b>Before inserting the replacement O-ring, clean the retaining slots with a cleaning solution.</b>
15	Position and secure the downstream connection (104) together with the downstream flange (105).
16	Unscrew the upstream fitting (102) together with the upstream flange (101) from the valve seat (2), together with the O-ring (17).
17	Remove and replace the O-ring (103) from the upstream fitting (102), lubricating it with synthetic grease.  <b>NOTICE!</b> <b>Before inserting the replacement O-ring, clean the retaining slots with a cleaning solution.</b>
18	Unscrew the valve seat (2) together with the O-ring (17) from the body (1).
19	Replace the O-ring (17) and lubricate it with synthetic grease.  <b>NOTICE!</b> <b>Before inserting the replacement O-ring, clean the retaining slots with a cleaning solution.</b>
20	Position and secure the valve seat (2) together with the O-ring (17) in the body (1).
21	Position and secure the body (1) together with the valve seat (2) to the O-ring (17) at the upstream connection (102).
22	Position and secure the upstream connection (102) together with the upstream flange (101).
23	Remove the O-ring (18) and replace it, taking care to lubricate it with synthetic grease.  <b>NOTICE!</b> <b>Before inserting the replacement O-ring, clean the retaining slots with a cleaning solution.</b>
24	Insert the plug guide (5) into the sleeve (7).



*VS/AM 58 flanged version*

Step	Action
25	Insert and secure the sleeve (7) together with the plug guide (5) in the body (1).
26	Insert the spring holder (6) together with the I/DWR ring (12).
27	Insert the spring (21).
28	Insert the plug (9) together with the ring nut (8) into the sleeve (7).

Tab. 9.42.

 **WARNING!**

**Ensure that all parts have been fitted correctly.**

9.4.4.2 - VS/AM 58 VERSION WITHOUT FLANGES

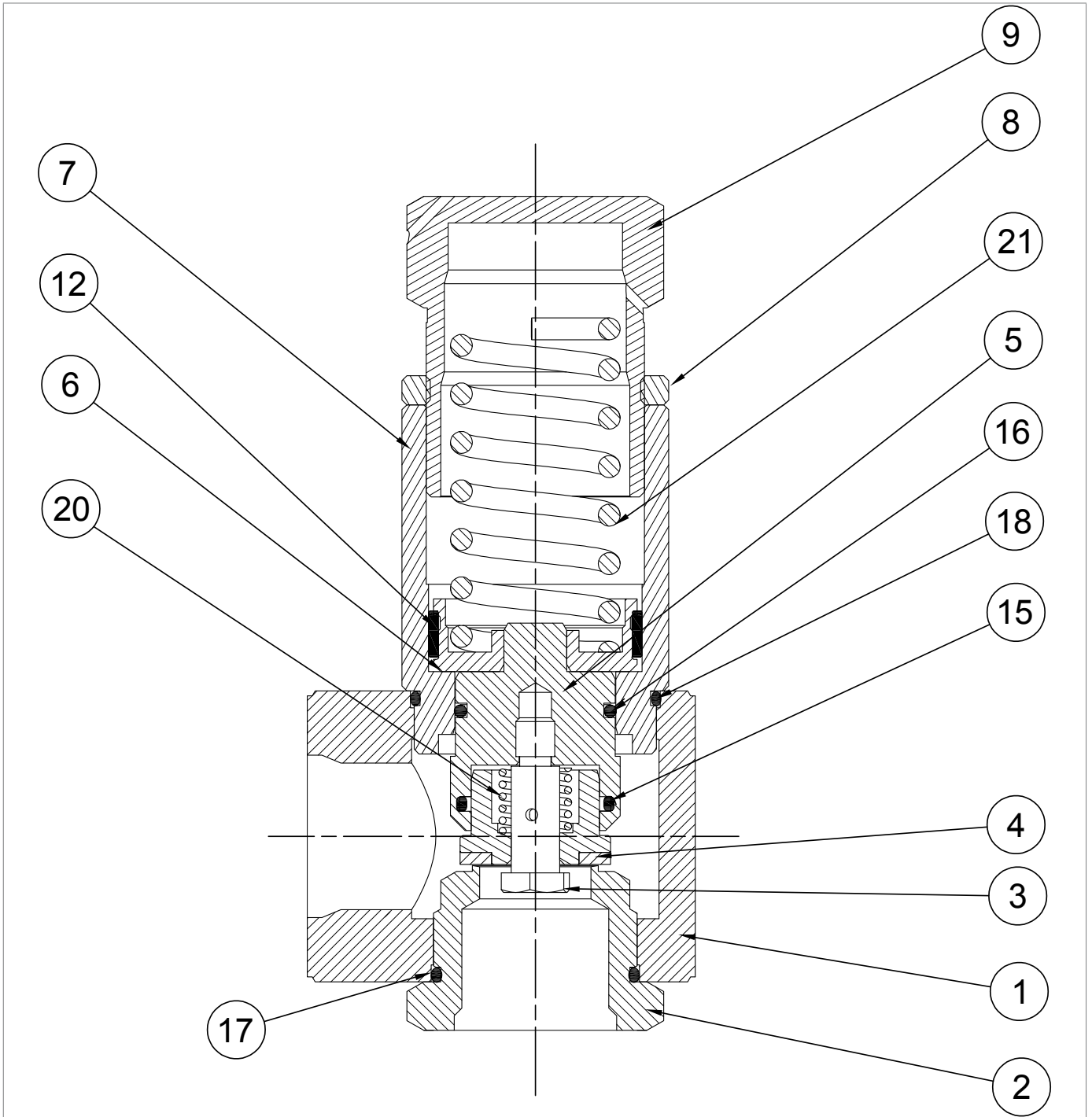

Fig. 9.11. VS/AM 58 version without flanges

Step	Action
1	Unscrew and remove the cap (9) together with the ring nut (8).
2	Remove the spring (21) together with the spring holder (6).
3	Unscrew the sleeve (7) together with the plug guide (5) and the I/DWR ring (12) from the body (1).
4	Replace the I/DWR ring (12), taking care to lubricate it with synthetic grease. <b>NOTICE!</b> <b>Before inserting the replacement I/DWR ring, clean the retaining slots with a cleaning solution.</b>
5	Separate the plug guide (5) from the sleeve (7).
6	Remove the O-ring (16) from the plug guide (5) and replace it, taking care to lubricate it with synthetic grease. <b>NOTICE!</b> <b>Before inserting the replacement O-ring, clean the retaining slots with a cleaning solution.</b>
7	Undo and remove the screw (3).
8	Remove the gasket (4).
9	Remove the spring (20).
10	Remove the O-ring (15) and replace it, taking care to lubricate it with synthetic grease. <b>NOTICE!</b> <b>Before inserting the replacement O-ring, clean the retaining slots with a cleaning solution.</b>
11	Insert the spring (20) together with the replacement gasket (4) into the plug guide (5).
12	Insert and fix the screws (3).
13	Unscrew the valve seat (2) together with the O-ring (17) from the body (1).
14	Replace the O-ring (17) and lubricate it with synthetic grease. <b>NOTICE!</b> <b>Before inserting the replacement O-ring, clean the retaining slots with a cleaning solution.</b>
15	Position and secure the valve seat (2) together with the O-ring (17) in the body (1).
16	Position and secure the body (1) together with the valve seat (2) to the O-ring (17).
17	Remove the O-ring (18) and replace it, taking care to lubricate it with synthetic grease. <b>NOTICE!</b> <b>Before inserting the replacement O-ring, clean the retaining slots with a cleaning solution.</b>
18	Insert the plug guide (5) into the sleeve (7).
19	Insert and secure the sleeve (7) together with the plug guide (5) in the body (1).
20	Insert the spring holder (6).
21	Insert the spring (21).
22	Insert the plug (9) together with the ring nut (8) into the sleeve (7).

Tab. 9.43.

**WARNING!**  
Ensure that all parts have been fitted correctly.

#### 9.4.5 - PROCEDURE FOR RECOMMISSIONING AFTER MAINTENANCE

 **NOTICE!**

For the recommissioning procedure, refer to the relevant paragraph.

## 10 - TROUBLESHOOTING

Below is a list of the cases (causes and services) that may occur over time in the form of malfunctions of various kinds. These situations depend on the conditions of the gas as well as on the natural ageing and wear of the materials.

### 10.1 - GENERAL WARNINGS

#### **HAZARD!**

Troubleshooting operations must be carried out by personnel:

- trained on workplace safety also based on the regulations in force in the place of installation of the device;
- qualified and authorised to carry out activities related to the device.

#### **WARNING!**



PIETRO FIORENTINI S.p.A. shall not be held liable for any damage to people and property due to services:

- other than those described;
- performed according to methods other than those specified;
- carried out by unsuitable personnel.

#### **NOTICE!**

Please call the Service Centre Authorised by PIETRO FIORENTINI S.p.A. if, in the event of a malfunction, you do not have the necessary qualified personnel for the specific intervention.

## 10.2 - OPERATOR QUALIFICATION SPECIFICATION

Troubleshooting	
Operator qualification	<ul style="list-style-type: none"> <li>User/specialist technician.</li> </ul>
PPE required	<div style="display: flex; align-items: center;">  </div> <div style="background-color: #f4a460; padding: 5px; margin-top: 5px;">  <b>WARNING!</b> </div> <p>The PPE listed in this table is related to the risk associated with the device. For the PPE required to protect against risks associated with the workplace, installation or operating conditions, please refer to:</p> <ul style="list-style-type: none"> <li>the regulations in force in the country of installation;</li> <li><u>any information provided by the Safety Manager at the installation facility.</u></li> </ul>
Equipment required	Refer to Chapter 7 'Commissioning/maintenance equipment'.

Tab. 10.44.

## 10.3 - TROUBLESHOOTING PROCEDURES

For proper troubleshooting, proceed as follows:

- close the upstream and downstream shut-off valves;
- refer to the troubleshooting tables listed below.

## 10.4 - TROUBLESHOOTING TABLE

Failure	Possible causes	Intervention
<b>Failed sealing</b>	Plug (5) damaged	Replace
	O-ring (15) damaged	Replace
	O-ring (16) damaged	Replace
	O-ring (17) damaged	Replace
	O-ring (18) damaged	Replace
	Valve seat (2) damaged	Replace the valve completely
	Filth or foreign bodies in sealing area.	Clean

Tab. 10.45.



## 11 - UNINSTALLATION AND DISPOSAL

### 11.1 - GENERAL SAFETY WARNINGS

#### HAZARD!



Make sure that there are no potentially explosive ignition sources in the work area set up to uninstall and/or dispose of the device.

#### WARNING!

Before proceeding with uninstallation and disposal, make the device safe by disconnecting it from any power supply.

### 11.2 - QUALIFICATION OF THE OPERATORS IN CHARGE

#### Commissioning

Operator qualification	<ul style="list-style-type: none"> <li>Installer.</li> </ul>
PPE required	 <p> <b>WARNING!</b></p> <p>The PPE listed in this table is related to the risk associated with the device. For the PPE required to protect against risks associated with the workplace, installation or operating conditions, please refer to:</p> <ul style="list-style-type: none"> <li>the regulations in force in the country of installation;</li> <li>any information provided by the Safety Manager at the installation facility.</li> </ul>
Equipment required	Refer to Chapter 7 'Commissioning/maintenance equipment'.

Tab. 11.46.

### 11.3 - UNINSTALLATION

#### ATTENTION!

Before uninstalling the device, completely drain the fluid in the reduction line and inside the device itself.

For proper uninstallation, proceed as shown in Tab. 11.47:

Step	Action
1	Close the valves upstream and downstream of the device.
2	Disconnect the upstream and downstream pipes from the device by unscrewing the fittings with adequate hand tools.
3	<p>Remove the device.</p> <p> <b>NOTICE!</b></p> <p><b>Seal the valves upstream and downstream of the device in the case of:</b></p> <ul style="list-style-type: none"> <li>closing the system;</li> <li>non-immediate replacement of the device.</li> </ul>

Tab. 11.47.

## 11.4 - INFORMATION REQUIRED IN CASE OF RE-INSTALLATION

### NOTICE!

Should the device be reused after uninstallation, refer to chapters:

- “Installation”;
- “Commissioning”.

## 11.5 - DISPOSAL INFORMATION

### NOTICE!

- **Proper disposal prevents damage to humans and the environment and promotes the reuse of precious raw materials.**
- **Bear in mind that the regulations in force in the country of installation must be complied with.**
- **Illegal or improper disposal involves the application of the penalties provided for by the regulations in force in the country of installation.**

The device is made of materials that can be recycled by specialised companies.  
For proper disposal of the device, proceed as specified in Tab. 11.48:

Step	Action
1	Prepare a large, clutter-free work area for safe dismantling operations.
2	Sort the various components by type of material for easier recycling through separate collection.
3	Send the materials obtained in <b>Step 2</b> to a specialised company.

*Tab. 11.48.*

The device in any configuration consists of the materials described in Tab. 11.49:

Material	Disposal/recycling indications
Plastic	It must be dismantled and disposed of separately.
Lubricants/Oils	They must be collected and delivered to the appropriate specialised and authorised collection and disposal centres.
Steel	Disassemble and collect separately. It must be recycled through the specific collection centres.
Stainless steel	Disassemble and collect separately. It must be recycled through the specific collection centres.
Aluminium	Disassemble and collect separately. It must be recycled through the specific collection centres.
Pneumatic/electric components	They must be dismantled in order to be reused if they are still in good condition or, if possible, overhauled and recycled.

*Tab. 11.49.*

### NOTICE!

**The above materials refer to standard versions. Different materials can be provided for specific needs.**

### NOTICE!

**Refer to chapter 9 “Maintenance and functional checks” to better identify the composition of the device and its parts.**

## 12 - RECOMMENDED SPARE PARTS

### 12.1 - GENERAL WARNINGS

#### NOTICE!

If spare parts not marked are used, PIETRO FIORENTINI S.p.A. their declared performance cannot be guaranteed.

It is recommended to use original spare parts PIETRO FIORENTINI S.p.A.

PIETRO FIORENTINI S.p.A. shall not be held liable for any damage caused by using non-original parts.

### 12.2 - HOW TO REQUEST SPARE PARTS

#### NOTICE!

For specific information, please refer to the sales network of PIETRO FIORENTINI S.p.A.

PAGE INTENTIONALLY LEFT BLANK

## 13 - CALIBRATION TABLES

### 13.1 - CALIBRATION TABLES

#### 13.1.1 - SAFETY VALVE VERSION

VS/AM 58 SPRING FEATURES							
Pos.	Spring item code	Spring colour	d	Lo	De	Min.	Max
1	2702080	Orange	5	100	35	15	18
2	2702290	Red	5.5			18.001	25
3	2702460	Green	6			25,001	30
4	2702660	Black	6.5			30.001	43

**d = Wire Diameter (mm) Lo = Spring Length (mm) De = External Diameter (mm)**

Tab. 13.50.

#### 13.1.2 - RELIEF VALVE VERSION

VS/AM 58 SPRING FEATURES							
Pos.	Spring item code	Spring colour	d	Lo	De	Min.	Max
1	2701275	Grey	3.5	115	35	2	3
2	2701541	White	4	100	35	3.001	4.4
3	2701800	Yellow	4.5	100	35	4,401	7,9
4	2702080	Orange	5	100	35	7,901	11,8
5	2702290	Red	5.5	100	35	11,801	20
6	2702460	Green	6	100	35	20,001	29
7	2702660	Black	6.5	100	35	29,001	44

**d = Wire Diameter (mm) Lo = Spring Length (mm) De = External Diameter (mm)**

Tab. 13.51.

TM0048ENG

