

ALL CONTROLS PTY LTD.

FOR ALL YOUR GAS,
COMBUSTION & CONTROL
EQUIPMENT REQUIREMENTS

Ph: 03 9123 1275 (East Coast)

Ph: 08 9277 4299 (West Coast)



ALL CONTROLS

Version 1.0

East Coast: vic.sales@allcontrols.com.au

West Coast: sales@allcontrols.com.au

ALL CONTROLS PTY LTD.

CONTACT DETAILS

EAST COAST:

vic.sales@allcontrols.com.au

14 MARKET DRIVE,
BAYSWATER NORTH,
VICTORIA 3153.

TEL: 03 9123 1275



WEST COAST:

sales@allcontrols.com.au

UNIT 7/175 CAMPBELL STREET,
BELMONT
WA 6104.

TEL: 08 9277 4299



ALL CONTROLS PTY LTD.



Are proud suppliers of the following manufacturers products.





All Controls Pty Ltd.

For all things Gas & Combustion

Useful Facts & Figures

1mJ = 1000BTU

1kW = 3.6mJ

1mW = 1000kW = 3600mJ

1m³ NG = 40mJ

1m³ LPG = 100mJ

1kG LPG = 50mJ

1kPa = 10mBar = 4"wg

7kPa = 1PSI = 28"wg

100kPa = 1Bar = 14.5PSI

Note that all figures are approximate only and have been rounded up or down for convenience

Ph: 03 9123 1275 (East Coast)

Ph: 08 9277 4299 (West Coast)

CONTENTS



VALVES:

SOLENOID, MOTORISED, SEISMIC,
COMBINATION, THERMOELECTRIC,
BALL VALVES, BUTTERFLY VALVES.

1

REGULATORS:

NATURAL GAS: APPLIANCE, STEP DOWN, OPSO, AIR/GAS RATIO.
LPG: 1ST STAGE, 2ND STAGE, TWO STAGE, AUTO CHANGEOVER, MANIFOLDS.
LPG PIGTAILS & ACCESSORIES, GAS FILTERS.

2

PILOTS & IGNITION:

NATURAL & LPG PILOTS,
THERMOCOUPLES, THERMOPILES. ELECTRODES & SENSORS, IONIZATION PROBES,
IGNITION TRANSFORMERS, HT LEADS, PIEZOS, CONNECTORS.

3

MEASUREMENT:

DIGITAL & "U" TUBE MANOMETERS, GAUGES, TEST POINTS, PRESSURE TEST
BLADDERS, TEST NIPPLES, DIGITAL THERMOMETERS, GAS HOSES & ACCESSORIES,
GAS FLOW METERS & BRACKETS.

4

ANALYTICAL:

COMBUSTION ANALYSERS,
DOMESTIC, COMMERCIAL & INDUSTRIAL FIXED GAS DETECTORS,
GAS SAFETY SYSTEMS.

5

PRESSURE:

AIR, GAS & DUCT PRESSURE SWITCHES,
LEAKAGE DETECTION, LEAK SPRAYS, SMOKE PELLETS.

6

WATER:

PRE-RINSE STANDARD, POT FILLER - HOB / DECK / WALL MOUNT,
HOB ELECTRONIC TAPWARE, HOSE REELS, WASHDOWN GUNS, KNEE BASINS, JUG
FILLERS, UNIVERSAL HOSES, SPRAY GUNS. WATER METERS.

7

THERMOSTATS:

SURFACE CONTACT, HOT WATER, CAPILLARY & BULB,
FAN LIMIT, PROGRAMMABLE THERMOSTATS

8

BURNER CONTROLS:

CONTROLS WITH INTEGRAL IGNITION, PROGRAMMED GAS & OIL CONTROLS,
SEMI AUTOMATIC BURNER CONTROLS,
FLAME DETECTORS.

9

BURNERS:

PACKAGE GAS & OIL, ATMOSPHERIC, PROCESS BURNERS,
ACTUATORS & SERVOMOTORS

10



Section 1

THERMO ELECTRIC VALVES

CATOBA, JADE, SIT

GAS CONTROL VALVES & SPARES

ROBERTSHAW, SIT

SOLENOID VALVES – GAS

GOLDSEAL, KROMSCHRODER

MOTORISED VALVES

KROMSCHRODER

MANUAL BALL VALVES

BROMIC, WATTS

MANUAL BUTTERFLY VALVES

CHALLENGER

ADJUSTABLE PORT VALVES

FIVES NORTH AMERICAN

BUTTERFLY VALVES

ECLIPSE, KROMSCHRODER

FIVES NORTH AMERICAN

SEISMIC VALVES

PACIFIC SEISMIC PRODUCTS

COMBINATION VALVES

KROMSCHRODER

THERMO ELECTRIC VALVES



SIT M1 Series

- Manual push button operation.
- Thermocouple operation.
- 500 kPa maximum.

#MIA - 1/4" F x F

#MIA14OFF - 1/4" M x M Flare Offset

#MIA38OFF - 3/8" M x M Flare Offset



SIT D3 Series

- Single valve.
- Thermocouple operation.
- Manual control.
- 15 and 20mm sizes available.
- Pilot take off.

#ST0440034 - 15mm F x F

#ST0440033 - 20mm F x F



Robertshaw 1720 Series

- Pilot & main flame operation.
- Thermocouple operation.
- 3/8" bsp connections.
- 1/2 PSI rated.

#RSTS11J

1.2

GAS CONTROL VALVES



Gas Heater Control Valve

- Pilot valve
- Main valve
- Igniter
- Thermocouple operation
- Gas control knob

#NY06801

Replaces Dungs BM733 Valve



SIT AC Gas Hot Water Control Valve

- Pilot valve.
- Main valve.
- Pressure regulator pilot.
- Pressure regulator main.
- Built-in energy cut-off safety device.
- Thermocouple.
- Natural Gas...

#SIT0.610.032 or #ST0610040



Robertshaw Gas Hot Water Control Valve

- Pilot valve.
- Main valve.
- Pressure regulator pilot.
- Pressure regulator main.
- Built-in energy cut-off safety device.
- Thermocouple.
- LPG only available.

#RS220RTSP596

GAS CONTROL VALVES



SIT Eurosit Valve

- Thermo electric flame failure.
- Adjustable gas flow.
- Thermostat with On/Off.
- Adjustable pilot flow.
- Inlet and pilot filters.

#ST0630...X



GAS SOLENOID VALVES



❖ Australian Approved



The GSV gas solenoid valve should be mounted directly in a vertical pipeline or in a horizontal pipeline with the coil uppermost.

Gold Seal Gas Solenoid Valves

- Fast open fast close.
- 15mm – 50mm sizes available.
- 15mm – 25mm: 36 kPa maximum pressure.
- 32mm – 50mm: 20 kPa maximum pressure.
- Integral filter.
- Blue neon light for visual indication.

#OGS-GSV15-240 #OGS-GSV32-240

#OGS-GSV20-240 #OGS-GSV40-240

#OGS-GSV25-240 #OGS-GSV40-240

GAS SOLENOID VALVES

1.5



Kromschroder VAS Series

- Fast open fast close.
- Slow open fast close.
- Combination valve.
- 50 kPa maximum pressure.
- 15-125mm sizes available.
- Various voltages.
- C/W screwed flanges.
- Closed Position Indicator option.
- Bypass kit available.
- Regulator and air/gas ratio versions available.
- Normally open vent valve available.
- Can be fitted together..

Part	Size	Fast	Slow
Number	BSP	Open	Open
KR151110F0	3/8"	Yes	
KR151110S0	3/8"		Yes
KR151115F0	1/2"	Yes	
KR151115S0	1/2"		Yes
KR151120F0	3/4"	Yes	
KR151120S0	3/4"		Yes
KR151125F0	1.0"	Yes	
KR151125S0	1.0"		Yes
KR151232F0	1.1/4"	Yes	
KR151232S0	1.1/4"		Yes
KR151240F0	1.1/2"	Yes	
KR151240S0	1.1/2"		Yes
KR151250F0	2.0"	Yes	
KR151250S0	2.0"		Yes
KR151365F0	2.1/2"	Yes	

1.5



Kromschroder VAN Series Vent Valve

- Normally open.
- # KR15611200 (20mm)
KR15611250 (25mm)

COMBINATION VALVES



Kromschroder CG Series

- On / Off.
- 15mm.
- Built in Regulator.
- 15 kPa Max Inlet Pressure.
- Test point fitted as standard.

#KR22070K



Kromschroder VaVario Series Combination Valves

- Pilot and Main gas combination.
- Integrated Regulator.
- Modular System.
- Configured to your requirements.

KR 155....as selected

Contact ALC for technical information

MOTORISED VALVES



Kromschroder VK Series

- Slow open, fast close actuated.
- 40-250mm sizes available.
- Screwed or flanged.
- 1 Bar pressure rating, 4 Bar available.
- CPI position switch available.
- Explosion proof actuator available.
- 240 / 110volt AC.

#KR18..... specify details

#KR18602 CPI Switch

Contact ALC for technical information.



ADJUSTABLE PORT VALVES



Needle Valves

- Precise control
- M x F 1/4"

#I0181



1807 Limiting Orifice Valve

- V-Port for setting gas/air ratio.
- Concealed Screwdriver adjustment.
- Sizes available 3/4" – 3" Available

#N1807-**

Contact ALC for further information.

MANUAL BALL & BUTTERFLY VALVES



Lever Handle Ball Valves

- AGA Approved.
- 1" – 2" BSP sizes available.
- 2600kPa Pressure rating.



Challenger Butterfly Valves

- For air and gas.
- AGA Approved.
- 50mm - 200mm sizes available.
- 1050kPa Pressure rating.
- Companion flanges & gaskets also available.

#BFLNEE50*****

Contact ALC for further technical information.

MOTORISED & MANUAL FLOW CONTROL VALVES



ECLIPSE BV Manual or Motorised Butterfly Valves

- Swing through disc handle.
- Sizes 15 - 200mm available.
Maximum pressure dependant on size.
- Maximum temperature 60°C.

Available on request, contact ALL CONTROLS
to discuss your requirements



Typical installation of KROMSCHRODER
IC 20 motor on ECLIPSE BV valve.
(IC 20 Motor Not Included)



KROMSCHRODER LFC (LINEAR CONTROL) VALVE

- Large control ratio of 25:1.
- 15 – 40mm screwed flanges.
- Direct mount for IC 20 & IC 40 motors.



Typical installation of KROMSCHRODER
IC 20 motor on KROMSCHRODER LFC
valve.
(IC 20 Motor Not Included)

1.10

MOTORISED BUTTERFLY VALVES



See Section 8.3 for Kromschroder IC20 & 40 Motor specifications.

Kromschroder DK Series

BVG: Control of Gas

- Maximum of 50kPa.
- Maximum of 60°C .

BVA: Control of Air

- Maximum of 50kPa.
- Maximum of 100°C.

DKR: Control of Air and Flue Gas

- Maximum of 30kPa.
- Maximum of 650°C.

SEISMIC VALVES



California Seismic Mechanical Gas Shut off Valves

- 3/4" - 8" Available.
- 4 Bar (60PSI).
- UL Listed.
- Screwed and Flanged available.
- Horizontal, vertical top inlet, vertical bottom inlet available.
- Optional micro switch monitoring (Factory fitted).

#CV 3.....specify size



Electrical Seismic Sensor

- UL Listed.
- Wall mount.
- 2 x SPDT output for Solenoid Valve.
- Alarm or BMS connection.
- Manual reset.

#CV 510

SEALANTS

1.11



Loxeal 18-10 Thread Sealant

- 100 ml.
- AGA Approval 5047.
- For NG & LPG up to 5 bar & 2" pipe size.

#BM-7170583



Bromic PTFE Thread Seal Tape

- 0.1mm x 12mm x 10m.
- AGA Approved..

#BM-7170381



Section 2

REGULATORS - NATURAL & LPG

BROMIC, JEAUVONS, MAXITROL, PIETRO FIORENTINI

OVER PRESSURE PROTECTION SYSTEMS

JEAUVONS, KROMSCHRODER, PIETRO FIORENTINI

REGULATORS - LP GAS

1ST STAGE

PIETRO FIORENTINI, DK, FISHER, HWA, REGO

2ND STAGE

DK, HWA, REGO

TWIN STAGE

CAVAGNA, FISHER, REGO

1ST STAGE AUTO CHANGEOVER

HWA

TWIN STAGE AUTO CHANGEOVER

BROMIC, HWA

AIR/GAS RATIO CONTROLS

KROMSCHRODER, NAMCO

GAS FILTERS

PIETRO FIORENTINI, KROMSCHRODER

HOSES & MANIFOLDS

BROMIC, GAMECO, KEEFER

NATURAL GAS APPLIANCE REGULATORS



Bromic Appliance Regulators

- 5kPa maximum inlet pressure.
- 0.75 - 1.5 kPa adjustable outlet.
- Test point.
- 75 mJ/hr.
- 3/8 & 1/2" BSP available.

#BM6160593, 3/8"

#BM6160595, 1/2"



Bromic 980L Appliance Regulator

- 5kPa maximum inlet pressure.
- 0.75 - 1.5 kPa adjustable outlet.
- 250 mJ/hr.
- 3/4" BSP.

#BM6160788



Maxitrol RV Appliance Regulator

- 3.4 kPa maximum inlet pressure.
- 0.75 - 1.5 kPa adjustable outlet.
- 250 mJ/hr.
- 3/4" BSP.

#BM6160788

STEP DOWN REGULATORS



Pietro Fiorentini 300 Series

- Stepdown Regulator for general applications.
- Safety Diaphragm.
- High flow rates.
- Powder coat finish.
- 50 kPa maximum inlet pressure.
- 3/4 - 1" bsp available.

#PF-30051-1.1 (7 – 20 mB) 1/2"

#PF-FAG-30051 (10 - 30 mB) 1/2"

#PF-30051-4 (25 – 70 mB) 1/2"

#PF-30051-7 (60 – 150 mB) 1/2"

#PF-30052-1.1 (7 – 20 mB) 3/4"

#PF-FAG-30052 (10 - 30 mB) 3/4"

#PF-30052-4 (25 – 70 mB) 3/4"

#PF-30053-1.1 (7 – 20 mB) 1"

#PF-FAG-30053 (10 – 30 mB) 1"

#PF-30053-4 (25 – 70 mB) 1"

#PF-30053-7 (60 – 150 mB) 1"

Jeavons J78 Equivalent

#PF-30051, 1/2"

#PF-30052, 3/4"

#PF-30053, 1"

Jeavons J48 Equivalent

#PF-30151, 3/4"

#PF-30152, 1"

#PF-30154, 1 1/2"

#PF-30155, 2"

While regulators are robustly made and finished all manufacturers recommend that some degree of weather protection is fitted. In particular vent ports should not be installed in such a way that moisture can enter the inside of the regulator.

NOTE: For inlet pressures over 7kPa downstream overpressure protection is generally required.

STEP DOWN REGULATORS

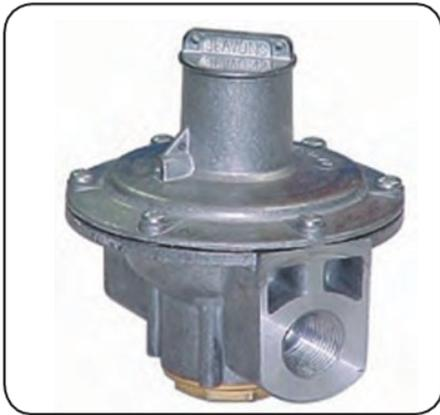

Jeavons J78 Regulators

For large domestic / small commercial applications.

- 10 kPa recommended maximum inlet pressure.
- Range of outlet springs available from 6mbar to 42mbar.
- 1/2, 3/4 & 1" bsp available.
- Up to 1200mJ/hr.

#J0001, 1/2"

#J0002, 3/4"

#J0003, 1"



Jeavons J48 Regulators

For large commercial applications

- 35 kPa maximum inlet pressure.
- Range of outlet springs available from 6mbar to 100mbar.
- 3/4 - 2" bsp available.
- Up to 18,500mJ/hr.

#J0005, 3/4"

#J0006, 1"

#J0007, 1 1/4"

#J0008, 1 1/2"

#J0009, 2"

2 1/2 & 3" available flanged, indent only

NOTE: For inlet pressures over 7kPa downstream overpressure protection is generally required.

OVER PRESSURE PROTECTION SYSTEMS



Pietro Fiorentini 320 Series with OPSO

- Safety Diaphragm.
- # PF-32051-2.75 (10 – 30mB) 1/2"
- # PF-32052-2.75 (10 – 30mB) 3/4"
- #PF-32052-4 (25 – 70mB) 3/4"
- # PF-32053-2.75 (10 – 30mB) 1"
- #PF-32053-4 (25 – 70mB) 1"



Pietro Fiorentini FE/FES Series

- Internal relief.
- Outlet pressure range 1.3 - 18 kPa.
- OPSO range 3.5 - 30 kPa.
- FE25 max. flow 25m³/h @ 30 kPa differential pressure.
- FES max. flow 50m³/h @ 50 kPa differential pressure.
- Inlet 1/2" Outlet 1".

#PF-FE25BP- (specify outlet pressure)

#PF-FESBP- (specify outlet pressure)



Pietro Fiorentini FEX/FEFS Series

- Internal relief.
- Maximum inlet pressure 8.6 bar.
- Outlet pressure range 1.3 - 10 kPa.
- OPSO range 3.2 - 16 kPa.
- FEX max. flow 75m³/h @ 45 kPa differential pressure.
- FEFS max. flow 100m³/h @ 50 kPa differential pressure.
- Inlet 1" Outlet 1 1/2".

#PF-FEXBP- (specify outlet pressure)

#PF-FEFSBP- (specify outlet pressure)



Pietro Fiorentini



Pietro Fiorentini DIVAL 500 Series

- 40mm BSP Dival500 LTR, OPSO Regulator with Partial Relief, 140kPa setpoint
- Outlet pressure: 30 - 250kPa.
- Maximum inlet: 20bar.

Contact All Controls for further information.



Pietro Fiorentini CIRVAL Regulator

- High-Capacity industrial regulator.
- Modular Design.
- Slam shut or monitor applications.
- 5.7 bar maximum inlet pressure.
- 69 kPa maximum outlet pressure.
- 1.1/4" – 2" NPT & ANSI 150

Contact All Controls for further information.



Jeavons J125 Regulators, 3/4" - 2"

- Step down regulator with integral overpressure device.
- Range of outlet pressure and OPSO springs is available.
- 25 kPa maximum outlet pressure.
- OPSO up to 50 kPa.

#J0150S10, 3/4", J0151S10, 1",

J0154S10, 1 1/2", J0155S10, 2"

Contact All Controls for further information.

2.6

OVER PRESSURE SLAM SHUT VALVES

NOTE: AS/NZS 5601.1:2022, Clause 5.11.2.3 (b) states that:
"A gas filter that will prevent the passage of foreign particles greater than 1mm SHALL be located upstream and within 5m of the device that shuts off the gas supply"

See later in this section for gas filter information



Kromschroder JSAV OPSO Device

- 4 bar inlet.
- Up to 55 kPa outlet trip pressure.
- 25 - 40mm screwed.
- 50, 65, & 80mm flanged.
- Manual reset.

#KR06****

PRESSURE RELIEF VALVES



Pietro Fiorentini VS/AM Series

- Diaphragm pressure relief.
- 65 – 100 mBar adjustment range.
- 20 Bar maximum inlet.
- 1" bsp.

#PF-VSAM65BP-7KPA



Jeavons J48K Series

- Diaphragm pressure relief.
- 12 – 150 mBar adjustment range.
- 350 mBar maximum inlet.
- 1" bsp.

#J0042

HIGH-CAPACITY REGULATORS



Pietro Fiorentini DIVAL 600 Regulator

High-Capacity industrial regulator.

- Modular Design.
- Slam shut or monitor applications.
- 20 bar maximum inlet pressure.
- Up to 420 kPa maximum outlet pressure.
- External impulse line.

Contact All Controls for further information.



Pietro Fiorentini NORVAL Regulator

High-Capacity industrial regulator.

- Modular Design.
- Slam shut or monitor applications.
- 16 bar maximum inlet pressure up to 3".
- 8 bar maximum inlet pressure 4" to 8".
- 440 kPa maximum outlet pressure.
- External impulse line.

Contact All Controls for further information

AIR/GAS RATIO CONTROLS



North American 7218 Series

- Inlet pressure up to 14 kPa
- Precise control of air / fuel ratio
- 3/4" - 4" npt available

#N7218-0, 3/4"

#N7218-1, 1"

#N7218-2, 1.1/4"

#N7218-3, 1.1/2"

#N7218-4, 2"

#N7218-6, 3"

#N7218-7, 4"



Kromschroder GIK Series

- Inlet pressure up to 20 kPa
- Maintains constant air / gas ratio
- 1/2" - 2" bsp available

#KR08***

GAS FILTERS



Pietro Fiorentini 106 series

- 1 MPa maximum pressure.
- High pressure test points.
- 50 micron filter element.
- 15mm to 50mm.

#PF-FIL-10601, 1/2" "

#PF-FIL-10602, 3/4"

#PF-FIL-10603, 1"

#PF-FIL-10605, 1.1/2"

#PF-FIL-10606, 2"

#PF-FIL-10606F, DN50 Flanged

#PF-FIL-10607F, DN65 Flanged

#PF-FIL-10608F, DN 80 Flanged

#PF-FIL-10609F, DN100 Flanged



Kromschroder GFK series

- 100/200/400 kPa versions available.
- 1/2" – 2.1/2" bsp screwed available.
- 1.1/2 - 10" flanged available.
- Single test point.
- Filter & "O" rings available as spares.

#KR02.....specify size

Available on request, subject to availability.

LP GAS REGULATORS

FIRST STAGE REGULATORS



REGO 597FA Series

- 1,750 mJ/hr (35 kG/hr)
- 1/4" NPT inlet & outlet.
- 1 - 15 psi adjustable outlet range.
- Outlet gauge tapping.
- "T" bar adjustment.

#RE597FA



Pietro Fiorentini HP100/B

OPSO Regulator

- 5000 - 14,000 mJ/hr.
- 35 - 80kPa outlet pressure (MP).
- 80 - 150kPa outlet pressure (TR).
- Maximum inlet pressure 20 bar.
- Integral relief.

#PF-HP100MP

#PF-HP100TR



DK Series 1st Stage regulator

- 2,900 mJ/hr. (50 kG/hr.).
- POL Inlet x 3/4" NPT outlet.
- 5 - 10 psi adjustable outlet range.
- Integral relief.

#DK-8622HPT3

SECOND STAGE REGULATORS



DK Series 2nd Stage regulator

- 1,300mJ/hr. (25 kG/hr.).
- 3/4" NPT Inlet x 3/4" NPT outlet.
- 2.75kPa outlet..
- Integral relief.

#DK-8622HPT3



REGO LV4403 B Series 2ND Stage Regulator

- 950 mJ/hr (19 kG/hr.).
- 1/2" NPT inlet x 1/2" NPT outlet.
- 2.75 kPa outlet pressure.
- Integral relief.

#RELV4403B4



REGO LV5503 B Series 2ND Stage Regulator

- 1,600 mJ/hr (32 kG/hr.)
- 3/4" NPT Inlet x 3/4" NPT outlet.
- 2.75 kPa outlet pressure
- Integral relief

#RELV5503B6

2.12

TWIN STAGE REGULATORS



REGO LV404B Series

- 525 mJ/hr (10.5 kG/hr).
- 1/4" NPT inlet x 1/2" NPT outlet.
- 2.75 kPa outlet pressure.
- Integral relief.

#RELV404B4



Fisher R632 Series

- 700 mJ/hr (14 kG/hr.).
- 1/4" NPT inlet x 3/8" NPT outlet.
- 2.75 kPa outlet pressure.
- Integral relief.

#FS-R632-BCF

AUTOMATIC CHANGEOVER MANIFOLDS



Automatic Changeover Manifolds

- Capacity: 500 Mj
- Supply Setting: 15 PSI
- Reserve Setting: 7 ½ PSI

#CL-175C14



Automatic Changeover Manifolds

- Capacity: 1 000Mj
- Supply Setting: 45 PSI
- Reserve Setting: 30 PSI

#CL-175CS6



Automatic Changeover Manifolds

- Capacity: 1500mJ
- Supply Setting: 15PSI
- Reserve Setting: 5PSI

#FI-749B/21

2.14

TWO STAGE AUTO CHANGEOVER REGULATORS



Cavagna 528B Series

- 400 mJ/hr. (8 kG/HR) & 600mJ/hr. (10 kG/hr).
- 2 x 1/4" inverted flare inlet x 1/2" BSP outlet.
- 2.75 kPa outlet pressure.
- Complete with pigtails, weather cover, bracket, chain and clips.

#BM6060553 400 mJ/hr.

#BM-6060554 600 mJ/hr.

2.14

LPG HOSES

2.15



Flexible Pigtails

- Stainless steel.
- Fully braided.
- Handwheel.
- POL x 1/4" Inv. Flare x 1000mm.

#BM-6SHW10010



Flexible Pigtails

- Stainless steel.
- Fully braided.
- Handwheel (Not shown).
- POL x POL x 900mm.

#GAL-HO-1654

LPG MANIFOLDS

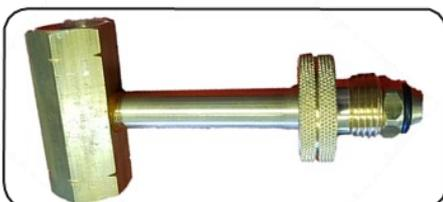

Brass Tee Manifold

- Female POLx Female POLx Male POL.
- Extended "Tee".
- With handwheel.
- Use in place of manifold.

#RE1350EY

LPG MANIFOLDS



Ball Valve

- 1/4" BSPM x 1/4" Inv. Flare.
- # GAM-BV375-7/16



Adapter

- 1/4" BSPF x 1/4" Inv. FlareM
- #GAM-330822-A



Section 3

PILOT BURNERS, COMMERCIAL

CATOBA, POLIDORO

PILOT BURNERS, INDUSTRIAL

KROMSCHRODER

PILOT MIXERS

FIVES NORTH AMERICAN

THERMOPILES

JADE, ALL CONTROLS

IGNITION ELECTRODES / SENSORS

CAST, CATOBA, NAMCO, POLIDORO, PSE

IGNITION LEADS

WIRE & CABLE, PSE

PIEZOS

CONCENTRIC, JADE

IGNITION TRANSFORMERS

KROMSCHRODER

THERMOCOUPLES

ALL CONTROLS

COMMERCIAL PILOT BURNERS



Catoba Multi Flame Pattern Pilot

- 2 or 3-way flame pattern
- Flame adjustment
- Accepts standard thermocouple and electrode
- Available in Natural Gas or LPG

#CB1334 – 3-way Natural Gas

#CB1335 – 3-way LPG



Ignition Electrode to suit Catoba
3-way Pilots.

#SI0915036



Flame Rod (Dog Leg) To
suit Catoba 3-way Pilots.

#SI0915044

3.2

INDUSTRIAL PILOT BURNERS



Kromschroder ZKIH

- Up to 7 kW capacity.
- For electronic ignition, ionization supervision.
- Available in Natural Gas or LPG.
- Lengths of 200-500mm available.
- Forced air supply.

#KR34** Specify length

❖ **INDENT ONLY**



Namco Pilot Assembly.

- Suitable for furnace type burners.
- Pilot Tip C/W Spark Plug.

#N4021-12

See page 5.1 for spark plug only



Pilot Mixer 3/4"

#N4031

3.2

INDUSTRIAL PILOT BURNERS



Kromschroder ZAI

- Light industrial or commercial use.
- Vertical flame, atmospheric.
- Option of flame length 40 - 100mm.
- Fitted with electrode and flame sensor as standard.
- Available in Natural Gas or LPG.
- 3 kW capacity.

#KR3404



Kromschroder Z T 13M - I

Natural Gas & LPG

- Use with KR01803, S11T FFD

#KR34075

3.4

THERMOCOUPLES



Interruptor Thermocouple

- Use with overtemp switch or safety device.
 - 600mm.
- #Z01616

THERMOPILES



All Controls

- Thermopile / pilot generator.
- 750 millivolt operation.
- 600mm and 900mm lengths.
- Long life.
- Fibreglass cable lead with split spade terminal.

#JD01202 – 600mm

#JD01204 – 900mm

IGNITION ELECTRODES & SENSORS

3.5



- Teardrop Bracket.
- 50mm Porcelain.
- 140mm Flame-Rod.

#B83450



Namco Direct Spark

- 1/2" BSP.
- 75mm Electrode.
- Earth Electrode.

#NR240-3203



UY6 Spark Plug

- For Namco 4021-12 Pilot Tip.

#NR240-2465

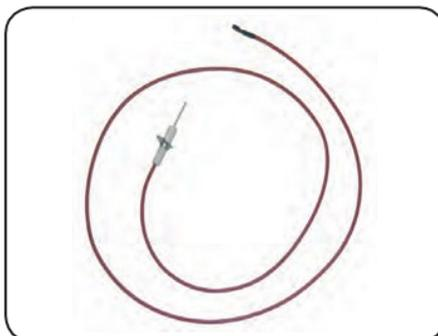

Robertshaw

- Spark plug and lead.
- Length 550mm.

#RS14060920

3.5

3.6

IGNITION ELECTRODES & SENSORS

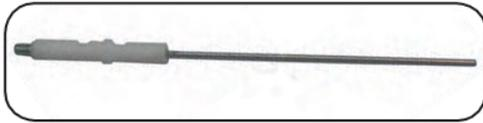

Universal Electrode

- 45mm porcelain body.
- 100mm flame rod.
- *Fits Catoba 3 way pilot & bracket.*

#Z8020



Flame Rod / Ignitor

- 300mm x 6mm.
- Optional clip and rubber boot.
- 1/4" BSP.

#Z8000



HT Connectors

#ELC15084

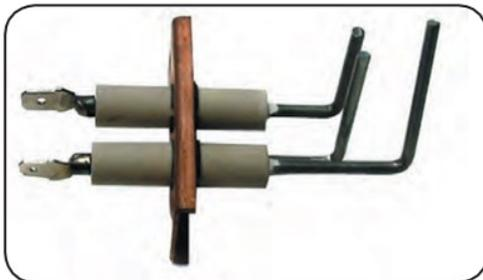

PSE Electrode

- Combination electrode / Sensor.
- Earth rod with bracket.
- 50mm reach.

#PS0060 OBSOLETE, NO REPLACEMENT

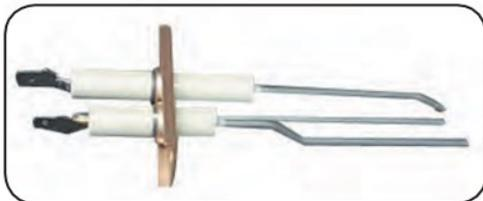

PSE Electrode

- Combination electrode / Sensor.
- Earth rod with bracket.
- 100mm reach.

#PS0070

IGNITION ELECTRODES & SENSORS

3.7



PSE Flame Sensor

- Diamond bracket.
- 40mm porcelain.
- 75mm flame rod.
- 1m Lead with spade connector.

#PS0042



- M14 thread.
- 40mm electrode.
- Earth electrode.

#ELC14502



- Angled ignition electrode for Catoba 3-way pilot.

#SI0915036



- Dog leg flame rod for Catoba 3-way pilot.

#SI0915044



- Straight ignition electrode for Catoba 3-way pilot.

#SI0915024

3.7

3.8

IGNITION LEADS



- Various lengths
- 1 x Female connector for piezo.
- 1 x Female connector for ignition electrode.

#HT500 - 500mm

#HT800 - 800mm

#HT1200 - 1200mm

#HT1500 - 1500mm



H.T Cable

- 7mm silicon HT cable.
- Wire conductor.
- 150°C rated.
- By the metre.

#RS.75HV7BL



- 3.5mm.
- Wire conductor.
- 150°C rated.
- By the metre.

#Z2195 (Red)

PIEZOS

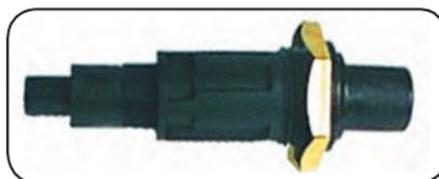

- *Standard duty.*

#CC03500

IGNITION TRANSFORMERS

3.9



- Electrical ignition of gas burners 1 x Female connector for piezo.
- Ignition transformers TZI and TGI are designed for high voltage.
- Ignition and burner control with a single electrode possible
- Ignition transformer TGI is supplied in a die-cast aluminum enclosure IP 65

krom
schroder

3.9

THERMOCOUPLES



Universal Kits

- Available in lengths 600 - 1800
- Fits all pilot burners.
- Unique conical locking nuts.
- Complete set of split nuts supplied.
- Easy installation.

#CC40600 – 600mm

#CC40900 – 900mm

#CC41200 – 1200mm

#CC41500 – 1500mm

#CC41800 – 1800mm

Section 4

DIGITAL MANOMETERS

DIGITRON, TESTO

“U” TUBE MANOMETERS

ALC

PRESSURE TEST BLADDERS

ALC

PRESSURE GAUGES

TEL THERM

PRESSURE TEST POINTS

BRAHMA

PRESSURE TEST NIPPLES

ALC

GAS FLOW METERS

ELSTER, LANDIS+GYR, PIETRO FIORENTINI

GAS FITTERS TEST KIT

SEE ALSO SECTION 4

GAS HOSES & ACCESSORIES

KEEFER, DORMONT (WHEN AVAILABLE)

MANOMETERS

4.1



Testo 512-1

- 0 - 60 Bar
- Differential input - high pressure connectors.
- Pressure: Selectable units: kPa, mBar, PSI, inH₂O, etc.
- Flow velocity: m/s, fpm

#TES0563-1512



Testo 512-2 High Pressure Manometer

- 0 - 200kPa.
- Differential input - high pressure connectors.
- Pressure: Selectable units: kPa, mBar, PSI, inH₂O, etc.

#TES0563-2512



Testo 510i Low Pressure Manometer

- 0 - 15kPa.
- Differential input.
- Requires Bluetooth connection to Smart Phone.

#TES0560-1510

4.1

4.2



Be sure **MANOMETERS**



Testo 549i

- 0 - 20kPa.
- Measurement of High & Low pressure.
- Low refrigerant loss thanks to hoseless application.
- Requires Bluetooth connection to Smart Phone.

#TES0560-254902

INFRARED THERMOMETERS



Testo 805i Smart Infrared Thermometer

- -5 to +250°C
- Requires Bluetooth connection to Smart Phone.

#TES0560-1805



Testo 915i Smart Infrared Thermometer

- -50 to +400°C.
- Flexible Probe, Air Probe, Immersion Probe, Surface Probe.
- Requires Bluetooth connection to Smart Phone.

#TES0563-5915

4.2



CLAMP THERMOMETERS



Testo 115i Clamp Thermometer

- -50 to +150°C.
- Pipe Size: 6 – 35mm
- Requires Bluetooth connection to Smart Phone.

#TES0569-1115

ANEMOMETERS



Testo 410i Smart Anemometer

- 0.4 to 30 m/s.
- Measurement of Air Flow Velocity, Volume Flow & Temperature.
- Requires Bluetooth connection to Smart Phone.

#TES0560-1410



Testo 440 Air Velocity & IAQ Measuring

- -50 to +400°C.
- Flexible Probe, Air Probe, Immersion Probe, Surface Probe.
- Requires Bluetooth connection to Smart Phone.

#TES0563-5915

4.4

MANOMETERS



Digitron PM-80

13kPa Digital Manometer

- Differential input - 8mm hose tails.
- Water resistant (IP67 rated).
- Rugged case with protective rubber boot.
- Magnetic attachment or tilt stand.
- Auto power off after 12 minutes.
- 0-13kPa measurement.
- Selectable units: kPa, mBar, PSI, "WG, etc.
- C/W 1m silicon tube.

#DG-PM80



Digitron 2022P

2 Bar Digital Manometer

- 0-200kPa.
- Differential input - high pressure connectors.
- Selectable units: kPa, mBar, PSI, "WG, etc.
- Protective rubber boot c/w tilt stand.
- connection kit available.

#DG-2022P

*Other pressure ranges available on request.

ACCESSORIES AVAILABLE:

1 x DG-2000BTBU: Protective boot.

DG-20ADAPTOR: Tube adaptor.

1 x ATZPB8X1.6: Gauge adaptor.

DG-20TUBE: 1m x 6mm Tube.



8 kPa U-Tube Manometer

Complete With:

- Hanging chain.
- Plastic tubing 0.8m.
- Protective front cover.
- Bottle of coloured liquid.

#MANO8



Pressure Test Bladder Kit

Complete With:

- Hand pump
- 3-way tee
- Plastic tubing

#TBK

GAUGES



- 63mm Dial.
- Stainless Steel Case.
- Brass Movement.
- 1/4 BSP Bottom Entry.

#ROS20006: 0 – 60mBar

#ROS20008: 0 – 100mBar

#ROS20016: 0 – 600mBar

PRESSURE TEST POINTS



Brass Test Point

- Screwed needle seal.
- Orifice: 0.7mm to meet AGA standards
- 1/8" and 1/4" BSP sizes available

#G0990CH - 1/8" BSP

#G0991 - 1/4" BSP



Test Nipples

Ideal for testing regulator outlet pressure.

- 1/2" available.
- Male / female.
- Complete with test point.

#Z0997 - 1/2" BSP

4.6



Pete's Plug

- Pete's Plugs will allow you to take pressure or temperature readings quickly and eliminate the need for leaving costly gauges or temperature indicators in the line.

- Brass bodied.

- 1/4" BSP

#PTB.GY

Pete's Plug Gauge Adaptor

- The pressure gauge adaptor has a probe made of 304 stainless steel
- The probe is 1.6mm in diameter and extends 2" on the standard adaptor.
- #ATZPB8X1.6

PIETRO FIORENTINI GAS METERS

4.7



Pietro Fiorentini

- G10 gas meter.
- 16 m³/h Capacity.
- C/W pulse output.
- CE approval 2004/22/CE.
- Natural Gas or LPG.
- 50 kPa maximum pressure.

#PF-MM10P



Pietro Fiorentini

- G16 gas meter.
- 25 m³/h Capacity.
- C/W pulse output.
- CE approval 2004/22/CE.
- Natural Gas or LPG.
- 50 kPa maximum pressure.

#PF-MM16P



Pietro Fiorentini

- G6 gas meter.
- 10 m³/h Capacity.
- C/W pulse output.
- CE approval 2004/22/CE.
- Natural Gas or LPG.
- 50 kPa maximum pressure.

#PF-RS2.4-G6P

4.7

4.8



Pietro Fiorentini Diaphragm Gas Meters

- G4 gas meter.
- 6 m³/h Capacity.
- C/W pulse output.
- CE approval 2004/22/CE.
- Natural Gas or LPG.
- 50 kPa maximum pressure.

PF-RS2001LA-G4P



Pietro Fiorentini Turbine Gas Meters

- G65 gas meter.
- 10 - 100 m³/h Capacity.
- Pulse output.
- Natural Gas or LPG.
- 100 kPa maximum pressure.

PFTMG65DN50 (Other sizes on request)



Pietro Fiorentini

- Gas meter Brackets.
- Brackets c/w nuts, tails & gaskets

#PF-20MM-BRACKET G4

#PF-25MM-BRACKET G6 & G10

#PF-40MM-BRACKET G16



L+G Model 750 Meter

- Aluminium case
- Low frequency pulse output available. (Can be retrofitted)
- Maximum pressure 50 kPa
- Capacity 7.5m³/h or 10.0m³/h
- Suitable for LPG or Natural Gas

#KR6602 7.5m³/h

#KR6602-610 10.0m³/h



Brackets and Connection Sets

Wall Bracket c/w 20mm tails

#KR6602BAR - 20mm

#Pulse Generator

#KR6602P



Meter Cover & Wall Bracket

- To suit 750 & AL 425 Meter
- Powder Coated Steel (White).
- Galvanised wall bracket.

#KR6602COVER

4.10



L+G Model 425 Meter

- Aluminium case
- Low frequency pulse output available (Can be retrofitted).
- Maximum pressure 70 kPa
- Capacity 12m³/h.
- C/W Tail set.

#AL12



AL12 Wall Bracket c/w 20mm tails

#MBAL12



Meter Cover

- To suit AL12 Meter
- Stainless Steel
- Galvanised wall bracket.

#MEGASAL12

GAS CONNECTORS

4.11

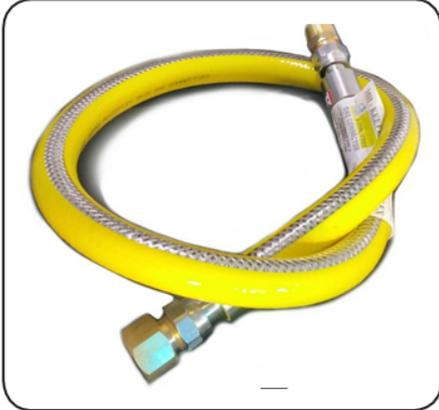

Appliance Gas Connectors

- PVC coated for food industry service.
- 3/4" diameter x 1200mm long.
- Male / female end fittings.

#432018-1200



Quick Disconnect Device

- Quick disconnect gas coupling.
- One hand action.
- Quick connect is self sealing.
- rated up to 140 kPa pressure.

#QDC20, 3/4"

#QDC25, 1"



Dormont Castor Mounted Appliance

"Blue" Connectors

- Heavy duty corrugated 304 stainless steel.
- Tight weave outer braid prevents overstretching.
- PVC coated for food industry service.
- 3/4 & 1" diameter available.
- 1200mm long.
- Male / female end fittings.
- Male end fitting internally threaded.

#DR036248, 3/4" x 1200mm

#DR036348, 1" x 1200mm

DORMONT SUBJECT TO AVAILABILITY

4.11

4.12



SS Gas Connectors

- Ideal for final connection in lieu of solid pipe.
- 1/2", 3/4" & 1" diameter available.
- Various lengths available.
- Male / female end fittings.
- Intended for permanent installation.

#KFC15-12, 1/2" x 300mm

#KFC15-18, 1/2" x 450mm

#KFC15-24, 1/2" x 600mm

#KFC15-30, 1/2" x 750mm

#KFC15-36, 1/2" x 900mm

#KFC15-48, 1/2" x 1200mm

#KFC20-12, 3/4" x 300mm

#KFC20-24, 3/4" x 600mm

#KFC20-36, 3/4" x 900mm

#KFC20-48, 3/4" x 1200mm

#KFC25-24, 1" x 600mm

#KFC25-36, 1" x 900mm



Dormont Appliance Restraint Kit

- As required by the Building code.
- 300mm shorter than corresponding hose length.
- Prevents stress on connector when appliance pulled out.
- Complete fitting kit.

#DR6148, 1200mm Restraint Kit

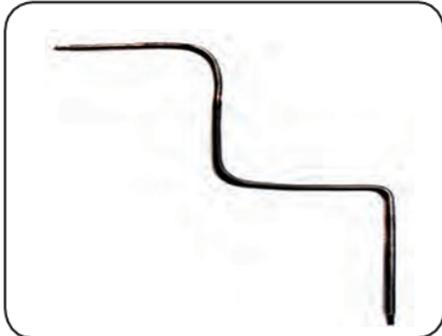

Stainless Steel Flextubes

- Ideal for pilot tubes in lieu of copper pipe.
- 25mm smooth neck for nut and olive.
- Bends easily around sharp corners.
- 1/4", 3/8" and 1/2" diameters available.
- Various lengths..

#KFT4-12, 1/4" x 300mm

#KFT4-18, 1/4" x 450mm

#KFT4-24, 1/4" x 600mm

#KFT6-06, 3/8" x 150mm

#KFT6-08, 3/8" x 200mm

#KFT6-12, 3/8" x 300mm

#KFT6-18, 3/8" x 450mm

#KFT6-24, 3/8" x 600mm

#KFT6-30, 3/8" x 750MM

#KFT6-36, 3/8" x 900mm

#KFT6-48, 3/8" x 1200mm

#KFT8-12, 1/2" x 300mm

#KFT8-24, 1/2" x 600mm

#KFT8-36, 1/2" x 900mm

DORMONT SUBJECT TO AVAILABILITY



Section 5

COMBUSTION ANALYSERS

TESTO

GAS FITTERS TEST KIT

ALC

GAS DETECTORS - PORTABLE

DIGITRON, HL, SLEEPSAFE

GAS DETECTORS - DOMESTIC

OCEANIA GAS SAFETY, SLEEPSAFE

GAS DETECTORS - DOMESTIC & COMMERCIAL

OCEANIA GAS SAFETY, SLEEPSAFE

GAS DETECTORS - INDUSTRIAL

OCEANIA GAS SAFETY,

GAS SAFETY PROTECTION SYSTEMS

OCEANIA GAS SAFETY

EMERGENCY STOP BUTTONS

ACCESSORIES

OCEANIA GAS SAFETY

COMBUSTION ANALYSERS



TESTO 310

- Measured values: oxygen, flue gas temperature and CO (0-2000ppm).
- Calculated values: combustion efficiency and carbon dioxide content.
- Hi contrast LCD display.
- Powered by four “AA” batteries.
- IR Printer Included in kit.

#TES0563-3110



TESTO 300 – NEXT LEVEL

- Measured values: oxygen, flue gas temperature and CO (0-2000ppm).
- Calculated values: combustion efficiency and carbon dioxide content.
- Rechargeable battery, USB mains unit.
- IR Printer Included in kit.
- Two-year warranty.

#TES0564 3002 71

All analysers come complete with combined sampling hose and temperature probe, with water trap and filter.



IR Printer

- Wireless infrared printer to suit TESTO Flue Gas Analysers.

#TES0554-3100

5.2

PORTABLE GAS DETECTORS



Digitron DGS-10

- Rubber protective boot as standard.
- 400mm flexible probe.
- Led illumination on sensing tip.
- Audible, adjustable tick rate with LED display.
- 9-volt battery.
- 10 ppm Methane sensitivity.
- Detects large range of gases.

#DG-DGS-10



TESTO 316

- Acoustic and visual alarm via multi-colour LED on the sensor head.
- Display of ppm / vol% / %LEL on the instrument.
- Flexible probe for difficult access locations.
- Sensor self test and automatic zeroing.
- Battery powered.

#TES0632-3172



TESTO 317

- Measuring range 0 – 1999ppm.
- Adjustable alarm threshold.
- No zero phase, immediate use.
- 3 Year sensor warranty.
- Battery powered, 2 x AAA batteries.

#TES0632-3173

PORTABLE GAS DETECTORS

5.3



HL Handheld Carbon Monoxide Detector

- 0-999 ppm measuring range.
- Resolution 1 ppm.
- Auto Power off Back Light.
- Uses 3 AAA batteries.
- Low Battery Indicator.
- Adjustable alarm level.
- Calibration Mode.

#HL7701

GAS FITTERS TEST KIT



Case Colour Indicative Only

Gas Fitters Test Kit

- Digitron PM80 Manometer. (#DG-PM80)
- Digitron Leak Detector. (#DG-DGS-10)
- HL CO Detector. (#HL7701)
- 0 – 100 Mb Dial Gauge (Not Shown) (#ROS20008)
- Metre Silicon Hose. (#48D)
- Hard Protective Case. (#SCA-326045)
- Items sold individually.

DG-TEST-KIT



Digitron PM-80

13kPa Digital Manometer

- Differential input - 8mm hoses.
- Water resistant (IP67 rated).
- Rugged case with protective rubber boot.
- Magnetic attachment or tilt stand.
- Auto power off after 12 minutes.
- 0-13kPa measurement.
- Selectable units: kPa, mBar, PSI, "WG, etc.
- C/W 1m silicon tube.

#DG-PM80

5.3

GAS DETECTORS

DOMESTIC / COMMERCIAL / INDUSTRIAL



Sleep Safe Carbon Monoxide Alarm

- Sealed for life Battery.
- Portable, free standing or mountable.
- 7 year sensor & battery life.
- 85 Decibel Alarm
- 3 Colour visual display
- Ideal for Homes / Boats / Caravans

#AH-COA-7



OGS Mini Merlin Gas Detectors

- Dual sensors in one controller, NG/CO or LPG/CO.
- Requires 240vac supply.
- Audible & Visual alarm.
- BMS & Fire alarm interface.
- Gas level indication.
- Gas shut off when suitable gas safety valve fitted.

#OGS-MMCH4CO (NG/CO) #OGS-LPGCO (LPG/CO)



OGS CO2 X Monitor

- CO² measured & displayed in PPM.
- Temperature displayed in °C or °F.
- Monitor, record & display average concentration over 8 hr. periods.
- Pre alarm & alarm relay output.

#OGS-CO2-X



OGS Gas Detectors

- NG, LPG & CO.
- Audible alarm option.
- Sensor end of life reminder.
- For use with all OGS-1000 & OGS-GDP panels.

#OGS-CH4 (Natural Gas)

#OGS-LPG (LPG)

#OGS-CO (Carbon Monoxide)

GAS SAFETY PROTECTION SYSTEMS

5.5



OGS Merlin 1000V

- Gas pressure proving system.
- Integral emergency stop button.
- Adjustable shut off timer.
- BMS & Fire alarm interface.
- Gas detector connections.
- Ventilation interlock.
- Gas pressure transducer included.

#OGS-1000V-GPS



OGS Merlin 1000V+

- Gas pressure proving system.
- Integral emergency stop button.
- Adjustable shut off timer.
- BMS & Fire alarm interface.
- Gas detector connections.
- Ventilation interlock.
- Electrical isolation.
- Gas pressure transducer included.

#OGS-1000V+-GPS



OGS Merlin 1000BH

- Gas pressure proving system.
- Integral emergency stop button.
- BMS & Fire alarm interface.
- Connections for two gas detectors..
- Gas pressure transducer included.

#OGS-1000BH

5.5

5.6

GAS SAFETY PROTECTION SYSTEMS



OGS Merlin GDP2 Gas Detection System

- Six Detectors, Two Zone.
- Integral emergency stop button.
- BMS interface.
- Requires OGS Gas Safety Valve.

#OGS-GDP2



OGS Merlin GDP4 Gas Detection System

- Twelve Detectors, Four Zone.
- Integral emergency stop button.
- BMS & Fire alarm interface.
- Requires OGS Gas Safety Valve.

#OGS-GDP4



OGS Merlin CT 1200S

- Gas ventilation interlock.
- Integral emergency stop button.
- BMS & Fire alarm interface.
- Monitor up to 2 fans.

#OGS-CT1200S



OGS Parksafe

- 0-10VDC output to variable speed drives dependent on CO & NO2 levels.
- Up to 16 detectors CO/NO2 in series.
- BMS & MODBUS connectivity.
- Quick and easy set up via digital touch screen.

#OGS-PARKSAFE

ANCILLARY PRODUCTS

5.7



OGS Gas Pressure Transducer

- 0 – 100 mBar.
 - 1/4" BSP connection.
 - IP65 protection.
- #OGS-PT



OGS Alarm Beacon

- Can be integrated with a wide range of fire alarm, gas detection and emergency stop devices.
 - 32 selectable sounds and volume control.
 - 8 flash patterns.
 - IP54 protection.
- #OGS-ALARM



OGS Air Pd Switch

- Differential pressure switch for air controls.
 - Alarm activation at pre-set value.
- #OGS-APS



Power Link Thermal Fuse

- Thermally operated.
 - 70°C fusing temperature.
 - Non resetting fuse.
 - Vented metal housing.
 - SPST contacts.
- #OGS-EP-TL2

5.8

EMERGENCY STOP BUTTONS



Manual Reset Module

- Provides manual reset control for emergency shut off valves.
- Simple mounting.
- Compact design.
- Illuminated push button.

#L0020RACL



Emergency Stop Switch Twist Reset

- Simple mounting.
- Compact design.
- C/W "Emergency Stop" Label.

#OGS-E-SHUT OFF



Keyed Emergency Stop Switch

- Lockable.
- Simple mounting.
- Compact design.
- C/W "Emergency Stop" Label.

#ESBK1



Gas Emergency Stop Label

- Sturdy Construction
- Engraved Lettering
- Large Size 200 x125 mm
- Self Adhesive

#L0201L-TRAF

Gas Emergency Isolation Label

#L0201L-TRAF



ALL CONTROLS PTY LTD.



Section 6

PRESSURE SWITCHES - GAS

KROMSCHRODER

PRESSURE SWITCHES - AIR

KROMSCHRODER, CLEVELAND

PRESSURE SWITCHES - DUCT

OCEANIA GAS SERVICES

VALVE LEAKAGE DETECTION SYSTEMS

KROMSCHRODER

AIR, GAS & DUCT PRESSURE SWITCHES



Kromschroder U Series (Gas & Air)

- Differential, Positive and Negative Pressure
- **AGA approval number 5484**
- DG 6U-3, 0.8 – 6.0 mbar #KR2000
- DG 10U-3 1.0 – 10 mbar #KR20008
- DG 50U-3 2.5 – 50 mbar #KR20010
- DG 150U-3 30 – 150 mbar #KR20012
- DG 500U-3 100 – 500 mbar #KR20014



Kromschroder H Series (Gas & Air)

- Manual Reset.
- Locks off with rising pressure.
- **AGA approval number 5484.**
- DG 10H-3 1 – 10mbar #KR20068
- DG 50H-3 2.5 – 50mbar #KR20070
- DG 150H-3 30 – 150mbar #KR20072
- DG 500H-3 100 – 500mbar #KR20074



Kromschroder N Series (Gas & Air)

- Manual Reset.
- Locks off with falling pressure.
- **AGA approval number 5484.**
- DG 10N-3 1 - 10mbar #KR20078
- DG 50N-3 2.5 – 50 mbar #KR20080
- DG 150N-3 30 – 150 mbar #KR20082
- DG 500N-3 100 – 500 mbar #KR20084

6.2



Kromschroder DL3A-3 (Air)

- Control of air as low pressure cut of and as limiting switch.
- Adjustable for positive, negative and differential pressure.
- 0.2 - 3mbar.
- Max 150mbar.

#KR20138



Cleveland AFS-222 (Air)

- SPDT switch that can be actuated by a positive, negative or a differential pressure with a field adjustable operating range.
- 0.2 - 12" (0.12 - 30mbar).

#CL0001



OGS Air Pd Switch

- Comes with 1m ducting tube & probe.
- 0.2 – 3.0mBar range.
- 10 Sec. drop out delay.
- Alarm activation at pre-set value.

#OGS-APS

LEAKAGE DETECTION SYSTEMS



Kromschroder TC3 R05 W/W

- Inbuilt pressure sensor.
- Fitted with 2 control gas valves.
- External mounting.
- 50kPa rating.
- 240 / 110v AC, 24V DC.
- AGA #8618.

#KR3220

6.2



Big Blu Micro Leak Detector Spray

- 1 Litre Spray Pack
- Practical & economical.
- Suitable for all gasses including Hospital Grade Oxygen.
- Non toxic.
- Food Industry Compliant.

#RT100S



Smoke Pellets

- Tube of 6.
- 40 Second burn time.
- 18 Cubic Metres of Non-Toxic Smoke.

#33.3003

Section 7

WATER METERS

ITRON

PRE-RINSE

GLOBAL TAPWARE

POT FILLERS

GLOBAL TAPWARE

ELECTRONIC TAPWARE

GLOBAL TAPWARE

KNEE BASINS

GLOBAL TAPWARE

JUG FILLERS

GLOBAL TAPWARE

WASHDOWN GUNS

GLOBAL TAPWARE

UNIVERSAL HOSES

GLOBAL TAPWARE

HOSE REELS

GLOBAL TAPWARE

WATER METERS



ITRON FLOSTAR

- Low flow accuracy.
- Peak flow capacity.
- Highly engineered materials.
- Available in 40 – 150mm



ITRON FLOSTAR M

- Fitted with CYBLE RF wireless link.
- Low flow accuracy.
- Peak flow capacity.
- Highly engineered materials.



ITRON TD8

- Low flow accuracy.
- Peak flow capacity.
- Highly engineered materials.
- Available in 20 – 32mm



ITRON Cabyle TM M-Bus

- Compatible with ALL ITRON water meters..
- Easily retrofitted to existing installations.
- Can be shipped ready mounted and configured.
- Electronic index is mirror image of mechanical index.
- Alarms for tampering detection & low h

For additional information contact All Controls PTY.



7.2

ELECTRONIC TAPWARE

GLOBAL HANDZFREE

Hob Electronic Tapware

HOB MOUNT



T72



T73



T74

HOSE REELS & WASHDOWN GUNS

GLOBAL WASH-WARE

Washdown Guns



W5



W6



W7



W8



GLOBAL WASH-WARE

Hose Reels Plastic



W1



W2



W3



W4



ALL CONTROLS

PRE-RINSE POT FILLERS

7.3

GLOBAL RINSE-MATE 

Pre-Rinse Pot Filler Models

HOB/DECK/WALL MOUNT



PRE-RINSE HANGING MODELS WALL MOUNT

GLOBAL FISHER 

Pre-Rinse Hanging Models WALL MOUNT

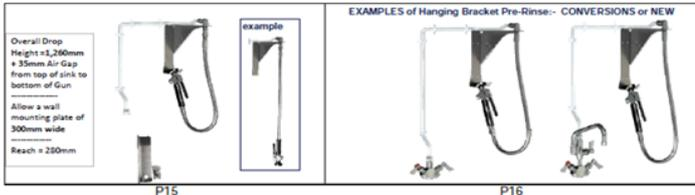

KNEE SINKS

GLOBAL HANDZFREE 

Knee Basins



7.3



JUG FILLERS

GLOBAL CATERING Stainless Steel Glass/Jug Fillers



ACCESSORIES

GLOBAL ACCESSORIES



Universal Guns, Spray Guns/Glass-Pot Filler Guns

Item	PHOTO	Pl. No.	WELS	Description
GLOBAL ACCESSORIES & SPARE PARTS - UNIVERSAL GUNS / Spray Guns / Glass - Pot Filler Guns				
A12		GF2949-2913A	WELS Reg. T14489 6 Star / 3.5 lpm	UNIVERSAL Pro-Rinse SPRAY GUN - Original - Flat Fan Spray Tip only. - <u>Use for Vic. Govt. WFFET rooms.</u> - Suits most genuine commercial PR set ups incl. g. Fisher / Rinse-Mate / Enware / Galvin / Encore / T&S / 3 Muz / MAG
A13		GF2949-2913A	WELS Reg. T40480 6 Star / 4.5 lpm	NEW - UNIVERSAL S/S SPRAY GUN - S/S Triple Jet Spray Tip only - Ideal for General & R.O. water applications Multi-Purpose- Spray Gun, Handle, 1/2" Male & Tribunf Adaptor
A14		GF2949HDL12M G500A	WELS Reg. T40480 6 Star / 4.5 lpm	S/S SPRAY GUN only - for General & R.O. water applications S/S Triple Jet Spray Tip + Handle & 1/2" Male S/S Triple Jet Spray Tip + Handle only
A15		G2949-B	WELS Reg. T40480 6 Star / 4.5 lpm	<u>S/S SPRAY GUN only - for General & R.O. water applications</u> S/S Jet Spray Tip suits- GLOBAL FISHER Stainless Steel Handle Special Code for 'True Wash' brand
A16		G50PR-A	Not For Sale WELS Reg- Pending TMxxxxx xStar / x lpm	PAN ROOM SPRAY GUN only. Angled Spray Head.
A17		G5208 G520812M	n/a	S/S SPRAY VALVE HANDLE only - suits Guns above. S/S SPRAY VALVE HANDLE + 1/2" Male - suits Guns above.
A18		G50PF-HDL12M	Not For Sale WELS Reg- Pending TMxxxxx xStar / x lpm	POT / KETTLE FILLER GUN & HANDLE supplied with Squeeze Lever Clip 'On/ Off' & Hooked Head.
A19		G50PF	Not For Sale WELS Reg- Pending TMxxxxx xStar / x lpm	SPRAY GUN - POT FILLER Hook - Aerator Style Tip
A20		G50GF-HDL12M	Not For Sale WELS Reg- Pending TMxxxxx xStar / x lpm	PAN ROOM SPRAY GUN only - Straight Spray Head
A21		G50GF	Not For Sale WELS Reg- Pending TMxxxxx xStar / x lpm	SPRAY GUN only - Glass Filler - Aerator Style Tip
A22		G500M-BK G500M-BL G50BR	n/a	SPRAY VALVE BUMPER - Black- suit- Fisher & Rinse-Mate SPRAY VALVE BUMPER - Blue- suit- Fisher & Rinse-Mate Brush to fit inside Bumper on Chrome only Fisher Guns Only

UNIVERSAL HOSES



GLOBAL ACCESSORIES

Universal Hoses, Specialty, Original Fisher

GLOBAL ACCESSORIES	ORIGINAL FISHER Mfg Co. PR Hoses		
A7		GF2918A	n/a UNIVERSAL Genuine FISHER Pre-Rinse HOSE Suits most genuine commercial PR set ups incl.g - Fisher / Rinse-Mate / Enware / Galvni / Encore / T&S / 3 Mkc / MAG ** NOTE:- Used for KFC Store work [Not Watermarked hose]
A8		GF2918	n/a Genuine FISHER Hose & Handle & ADAPTORS - 915mm suits - T & S / Encore / Fisher / Rinse-Mate [not Watermarked]
A8		GF2914	n/a Genuine FISHER HOSE only - Standard 915mm c/w 1/4" Male x 3/4unt male [not Watermarked] ** NOTE:- Used for KFC Store work
A9		GF2914-C	n/a Genuine FISHER HOSE only Cafe 660mm Long c/w 1/4" Male x 3/4unt male [not Watermarked]
A10		GF2918-2949-1	GUN - WELS Reg. T40480 6Star / 4.5 lpm GLOBAL FISHER GUN & Genuine FISHER HOSE :- Type 1 Contains :- G2949-B (Gun), G5208 (Handle), GF2918 (Hose) + 1 x Adaptor ** NOTE:- Used for KFC Store work [Not Watermarked hose]
A11		GF2918-2949-2	GUN - WELS Reg. T40480 6Star / 4.5 lpm GLOBAL FISHER GUN & Genuine FISHER HOSE :- Type 2 Contains :- G2949-B (Gun), G5208 (Handle), GF2918 (Hose) + 2 x Adaptors ** NOTE:- Used for KFC Store work. [Not Water Marked hose]

Item	PHOTO	Pl. No.	Details	Description
GLOBAL ACCESSORIES UNIVERSAL HOSES / Pre-Rinse Hoses				
A1		GPRH900U GF2918A GPRH970U	900mm 900mm 970mm	NEW Style <u>UNIVERSAL</u> S/S Pre-Rinse Hose - "Watermarked". Designed to suit all genuine PR Hoses & configurations. The 900mm Hose is supplied as a Fisher Alternative hose under its own code or previous Fisher code (GF), with the 970 long as option.
A2		GPRH0650M GPRH0900M GPRH0970M	650mm 900mm 970mm	NEW Style <u>MULTI-PURPOSE</u> S/S Pre-Rinse Hose - "Watermarked". Designed to suit all genuine PR Hoses & configurations.
A3		GPRH0650F GPRH0900F GPRH0970F	650mm 900mm 970mm	NEW Style <u>Fisher</u> Alternative S/S Pre-Rinse Hose - "Watermark" w/ 1/2"FI Swivel Ends + Adaptors to Suit Fisher Hose setup
A4		GPRH0650S GPRH0730S GPRH0900S GPRH0970S GPRH1000S GPRH1500S GPRH2000S GPRH3000S	650mm 730mm 900mm 970mm 1mt 1.5mt 2mt 3mt	NEW Style - <u>Standard</u> S/S Pre-Rinse Hose. "Watermarked" comes with 1/2"FI Swivel Ends & thick Fibre Washers to allow rotation.
GLOBAL ACCESSORIES Specialty made PR Hoses				
A5		GPRD915UK GPRD860UK GPRD750UK GPRD600UK	915mm 860mm 750mm 600mm	Multi Purpose <u>Domestic</u> Type FLEXIE Hose- Braided & PVC Coated - 8mm I.d. x 1mt long - c/w 1/2" x 3/8" Female ends + a special adaptor :-M1 x 3/8 Nipple. Suits: <u>Wolren, Gentec, Other</u>
A6		OF500P-SS OF750P-SS OF1000P-SS OF1500P-SS	500mm 750mm 1mt 1.5mt	OZFLEX™ Fully 304 STAINLESS STEEL FLEXIE Hose S/S Braided PVC Coated. w- 1/2" S/S Female Nut & Tails, Crimped. <i>suitable for R.O. Application</i>



ACCESSORIES

GLOBAL ACCESSORIES



Universal Guns, Spray Guns/Glass-Pot Filler Guns

Item	PHOTO	Pt. No.	WELS	Description
GLOBAL ACCESSORIES & SPARE PARTS - UNIVERSAL GUNS / Spray Guns / Glass - Pot Filler Guns				
A12		GF2949-2913A	WELS Reg. T14469 6 Star / 3.5 lpm	UNIVERSAL Pre-Rinse SPRAY GUN - Original - Flat Fan Spray Tip only. - Use for VIC Govt VEET prog. Suits most genuine commercial PR set ups incl.g - Fisher / Rinse-Mate / Enware / Galvin / Encore / T&S / 3 Mkz / MAG
A13		GF2949-2913A	WELS Reg. T40480 6 Star / 4.5 lpm	NEW - UNIVERSAL S/S SPRAY GUN - S/S Triple Jet Spray Tip only - Ideal for General & R.O. water applications Multi-Purpose- Spray Gun, Handle, 1/2" Male & 7/8" Adaptor
A14		GF2949HDL12M G500A	WELS Reg. T40480 6 Star / 4.5 lpm	S/S SPRAY GUN only - for General & R.O. water applications S/S Triple Jet Spray Tip + Handle & 1/2" Male S/S Triple Jet Spray Tip + Handle only
A15		G2949-B	WELS Reg. T40480 6 Star / 4.5 lpm	<u>S/S SPRAY GUN only - for General & R.O. water applications</u> S/S Jet Spray Tip suits- GLOBAL FISHER Stainless Steel Handle Special Code for 'True Wash' brand
A16		G50PR-A	Not For Sale WELS Reg. Pending TMxxxxx xStar / x lpm	PAN ROOM SPRAY GUN only. Angled Spray Head.
A17		G5208 G520812M	n/a	S/S SPRAY VALVE HANDLE only - suits Guns above. S/S SPRAY VALVE HANDLE + 1/2" Male - suits Guns above.
A18		G50PF-HDL12M	Not For Sale WELS Reg. Pending TMxxxxx xStar / x lpm	POT / KETTLE FILLER GUN & HANDLE supplied with Squeeze Lever Clip "On/ Off" & Hooked Head.
A19		G50PF	Not For Sale WELS Reg. Pending TMxxxxx xStar / x lpm	SPRAY GUN - POT FILLER Hook - Aerator Style Tip
A20		G50GF-HDL12M	Not For Sale WELS Reg. Pending TMxxxxx xStar / x lpm	PAN ROOM SPRAY GUN only - Straight Spray Head
A21		G50GF	Not For Sale WELS Reg. Pending TMxxxxx xStar / x lpm	SPRAY GUN only - Glass Filler - Aerator Style Tip
A22		G50BM-BK G50BM-BL G50BR	n/a	SPRAY VALVE BUMPER - Black- suit- Fisher & Rinse-Mate SPRAY VALVE BUMPER - Blue- suit- Fisher & Rinse-Mate Brush to fit Inside Bumper on Chrome only Fisher Guns Only



ALL CONTROLS PTY LTD.



Section 8

CAPILLARY & BULB THERMOSTATS

JUMO

FAN LIMIT THERMOSTATS

HONEYWELL

HOT WATER THERMOSTATS

8.1



JUMO Limit Thermostat

- Adjustable 20 - 150°C.
- Manual reset.
- SPDT contacts.
- 1M capillary.

#CP40140/N



JUMO Limit Thermostat

- As above but installed in an enclosure.

#CP40140CE/N (20 – 150 Deg).

8.1

FAN LIMIT THERMOSTATS

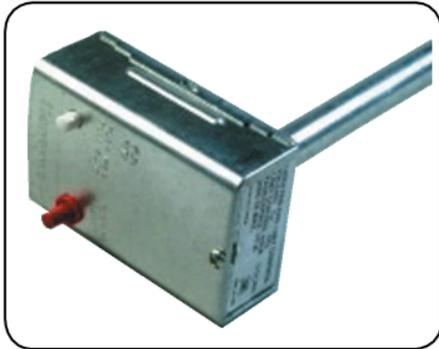

Honeywell L4064N Fan & Limit Thermostat

- 50°C fan off control (auto reset).
- 93°C hi limit (manual reset).
- 290mm probe.
- Fan switch makes & hi limit breaks on temperature rise.
- Swivel fitting.

#HWL4064B2210



ALL CONTROLS PTY LTD.



Section 9

BURNER CONTROLS - INTEGRAL IGNITION

FENWAL

BURNER CONTROLS - PROGRAMMED

KROMSCHRODER, SIEMENS

BURNER CONTROL - SEMI AUTOMATIC

PACTROL

FLAME DETECTORS

SIEMENS. KROMSCHRODER

BURNER CONTROLS WITH INTEGRAL IGNITION



FENWAL BURNER CONTROL C/W WIRING LOOM

- 12 VDC.
- Integral Ignition transformer.
- Inter purge time 25 seconds.
- Trial for ignition time (TFI) 10 seconds.

FW-35-53056-035

9.2

PROGRAMMED GAS & OIL BURNER CONTROLS

All Controls PTY LTD. carry a full range of burner controls to suit the Riello brand of burners.

We endeavour to have most brands of commonly used burner controls available.

Special requirements are available on indent.

Riello Siemens Equivalents.

RMO88.53A1 - LMO88.530A1RL

RMO88.53A2 - LMO88.530A2RL

RMG88.62A1 - LMO88.620A1RL

RMG88.62A2 - LMO88.620A2RL

RMG/M88.62A2 -LMO88.621A2RL



SIEMENS



SIEMENS LMV BURNER CONTROLS

9.3

Siemens LMV5..

- Burner control with gas valve proving system.
- Electronic fuel-air ratio control.
- Optional PID temperature or pressure boiler load control.
- Optional VSD module available.
- Optional O₂ trim control available.

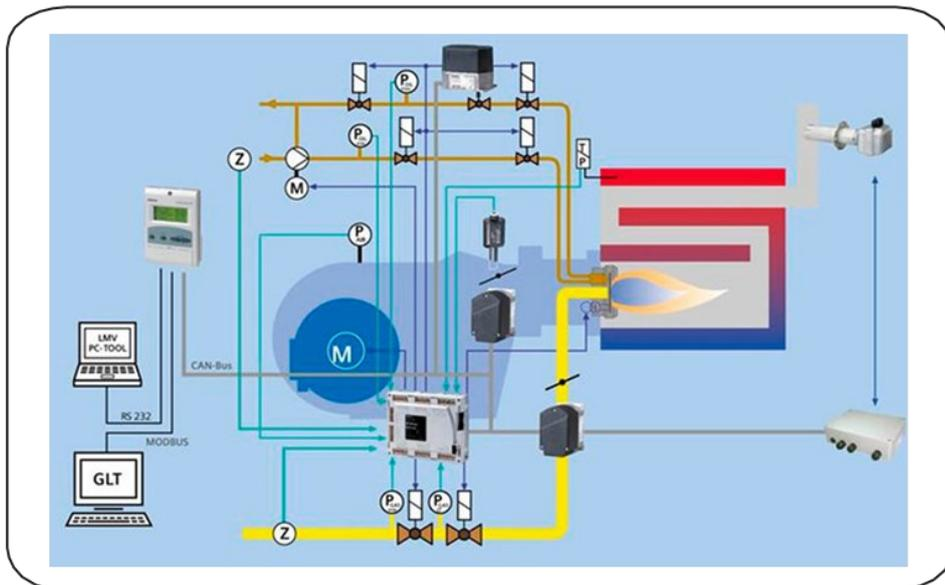

9.3

9.4

SIEMENS PROGRAMMED OIL & GAS BURNER CONTROLS



Siemens LFL1.635 CONTROL

Forced draught modulating gas burner control

- Plug in base (AGM410400550).
- Pilot / Main gas valves.
- Remote reset / Flame failure indicator.
- Pre-purge 60 seconds, (30 seconds LFL1.335).
- QRA UV cell / ionization control.
- Flame failure safety time - 5 seconds.
- Air pressure proving / Fan control.
- 240 or 110 volt AC.

#LFL1.635 (#LFL1.335)



Siemens LOA 24.171B27

- Atmospheric Gas burner control.
- Plug in base (AGK11/65).
- Remote reset / flame failure indicator.
- 2 Stage operation.
- Post ignition time 10 seconds.
- QRB flame detector.
- 240 volt AC.

#LOA24.171B27

kromschroder

9.5



Kromschroder FDU Flame Detector Unit

- Replaces IFW 15/50, R4343 & BC 1000
- Contact All Controls for further information



Kromschroder IFS 110-IM CONTROL

- Forced draught gas burner control.
- Plug in base.
- Pilot / Main Gas Valves.
- Remote reset / Flame Failure Indicator.
- Pre-Purge 5 seconds.
- Flame Failure Safety Time - 5 seconds.
- Single electrode / UV Cell.
- 110/240 volt AC.

#KR28086

KROMSCHRODER BURNER CONTROLS



Burner Control BCU 370

- For modulating, forced draught burners for gas unlimited capacity in intermittent or continuous operation.
- Control of Fan & Butterfly Valve
- Optionally available with integrated field bus interface for simple wiring
- AGA# 680



Burner Control BCU460, BCU465

- For burners in intermittent operation or in continuous operation
- Flame control by UV, Ionization, or a further option of using the furnace chamber temperature.
- With optional valve proving system
- Fieldbus connection (PROFIBUS, PROFINET, Ethernet/IP) using optional bus module.
- AGA# 6478



Burner Control BCU 570

- For monitoring and controlling modulating individual burners and forced draught burners of unlimited capacity
- For directly ignited burners or burners ignited by a pilot burner in intermittent or continuous operation
- With optional valve proving system
- Flexible range of applications due to parameterization possibilities
- Optional bus module for fieldbus connection UV Sensors UVS 5 UVS10
- Also Available BCU560, BCU565 and BCU580
- AGA# 8321

SEMI AUTOMATIC BURNER CONTROLS

9.7



Siemens LFS1... CONTROL

- Plug in base.
- UV Cell - Series QRA, RAR9 or Flame Rod sensing.
- Electrical open contact..
- Electrical closed contact.
- 240 volt AC.

#LFS1.21A2



LFS1 Flame Relay Base

#AGK11.7

Cable Gland Holder

#AGK65

LFE to LFS Adaptor

#KF8896

9.7

FLAME DETECTORS



Siemens QRA4U

- Flame detector (Oil & Gas)

#QRA4.U



Siemens QRA2

UV Detector (for gas)

#QRA2[1]



Siemens RAR9

Photo cell (for oil)

#RAR9[1]



Siemens QRB 1

Photo cell (for oil)

#QRB1....specify full code

FLAME DETECTORS

9.9



UV Sensors UVS5, UVS10

- Virtually immune to interference due to its insensitivity to daylight, infrared radiation, and incandescent bulbs
- Maximum safety thanks to protection against discontinuity or short-circuit on the flame signal cable.
- Comply with the requirements of EN 298 in conjunction with Kromschöder automatic burner control units.



UV Flame Detector UVC1

- Enhanced flexibility thanks to adjustable switch-off threshold
- Virtually immune to interference during operation due to its insensitivity to daylight, infrared radiation, and incandescent bulbs
- High operational safety thanks to self-test
- For systems up to SIL 3 pursuant to EN 61508 and continuous Operation to EN 298

Section 10

PACKAGE BURNERS - GAS & OIL

RIELLO

INDUSTRIAL DUAL FUEL BURNERS

RIELLO

DUCKBILL & MONGOLIAN BURNERS

AIR HEAT BURNERS

ECLIPSE, FIVES NORTH AMERICAN

IMMERSION TUBE BURNERS

FIVES NORTH AMERICAN

ACTUATORS

BELIMO, KROMSCHRODER



PACKAGE BURNERS – GAS & OIL



Riello 40 GS Series

- On / Off
- GS3 – GS20 11 – 220 kW
- Two Stage & Modulating versions available.
- 11 – 220 kW.



Riello RS Series

- On / Off.
- Two Stage & Modulating also available.
- 80 – 11,100 kW.



Riello 40 G Series Light Oil Burners

- On / Off
 - G3 – G20S 24 - 240 Kw
- Two Stage also available
- 40G10 54 – 120 kW
 - 40G20S 95 – 240 kW



Riello RL Series Light Oil Burners

- On/Off.
- Two Stage.
- Progressive two stage and modulating also available.
- 95 - 4,410 kW



PROCESS BURNERS – GAS

A full range of Eclipse burners is now available for all process and heating applications.
Contact All Controls to discuss your requirements.

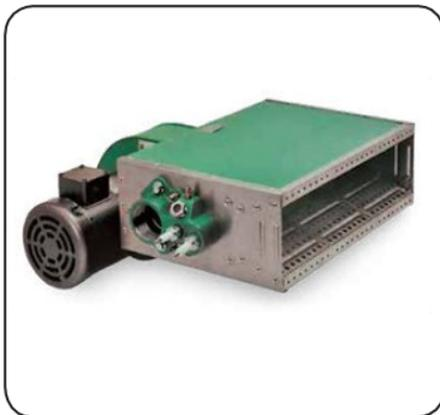

ECLIPSE AH Series AirHeat Burner

- Duct burner
- High turn down
- Stainless steel
- *Available with gas train and burner control if required

Capacities:

- #AH0050 – 6", Max. Input - 147kW
- #AH0100 – 12", Max. Input – 293kW
- #AH0150 – 18", Max. Input – 440Kw
- Up to 1172kW

Please Contact ALL CONTROLS for further technical information



ECLIPSE ThermJet Burner

- High performance velocity burners.
- High turn down.
- Capacities from 40 – 5280 kW.
- Available with gas train and burner control.

Please Contact ALL CONTROLS for further technical information.

PROCESS BURNERS – GAS



Namco Zephyr Air Heat Burners

- Versatile Air Heat Burners for duct or fan assisted applications.
- 50:1 Turndown.
- 500 - 9000mJ Models available.
- Gastrain & Burner controls available.

Please Contact ALL CONTROLS

for further technical information

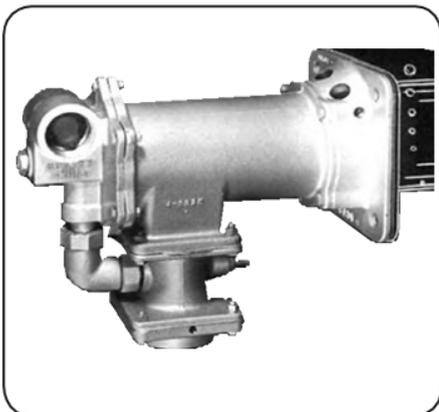

Namco 4762 Immersion Tube Burners

- High heat release
- High turndown
- UV or flame rod
- Reliable premix pilot
- 200mJ - 4,200mJ models available

Please Contact ALL CONTROLS

for further technical information

10.4

ATMOSPHERIC BURNERS



Duckbill / Mongolian Burners

- Suitable for commercial wok applications.
- Available with 18, 28, 23 and 32 jets.
- Natural Gas or LPG.

18 jet Duckbill Burner 200mm Diameter

- 1/2" BSP inlet.
- 120 mJ/h @ 1kPa NG 1.2mm Jet.
- 120 mJ/h @ 2.75 kPa LPG 0.7mm Jet.

#HC18J-120, NG

#DBLP18J, LPG



28 jet Duckbill Burner 280mm Diameter

- 3/4" BSP inlet.
- 180mJ/h @ 1kPa NG 1.2mm Jet.
- 180mJ/h @ 2.75 kPa LPG 0.7mm Jet.

#HC28J-120, NG

#DBLP28J, LPG



23 jet Mongolian Burner 150mJ/h

- 1/2" BSP inlet.
- 150mJ/h @1 kPa NG 1.2mm Jet .
- 150mJ/h @2.75 kPa LPG 0.6mm Jet.

#WS1023-120, NG

#WS1023-070G, LPG



32 jet Mongolian Burner 200 mJ/h

- 3/4" BSP inlet.
- 200mJ/h @1 kPa NG 1.2mm Jet
- 200mJ/h @2.75 kPa LPG 0.6mm Jet.

#WS1032-060, NG

#WS1032-060G, LPG

ACTUATORS



Kromschroder IC 20 Series

- 0 - 90° Movement.
- 240 or 120 volt AC Supply.
- Automatic or manual operation.
- Three point step signal control.
- 7.5 - 60 seconds running time.
- External readable position indicator.
- "E" model available with electronic 4 - 20mA card.

#KR1952130



Belimo Dampers & Actuators

- Full range of Belimo dampers and actuators available.

#BE*****



ALL CONTROLS